

CLP-310 Series

Color Laser Printer

User's Guide

imagine the possibilities

Thank you for purchasing a Samsung product. To receive a more complete service, please register your product at

www.samsung.com/global/register



features of your new laser product

Your new machine is equipped with a number of special features that improve the quality of the documents you print. With the machine, you can:

SPECIAL FEATURES



Print with excellent quality and speed

- You can print in a full range of colors using cyan, magenta, yellow, and black.
- You can print with a resolution of up to 2400 x 600 dpi Effective output.
- Your machine prints A4-sized paper at up to 16 ppm, letter-sized paper at up to 17 ppm in gray scale mode and 4 ppm in color mode.

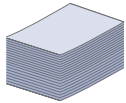

Handle many different types of printable material

- The 150-sheet tray supports plain paper in various sizes, letterhead, envelopes, labels, custom-sized media, postcards, and heavy paper.

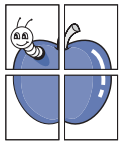

Create professional documents

- Print watermarks. You can customize your documents with words, such as "Confidential". See *Software section*.
- Print posters. The text and pictures of each page of your document are magnified and printed across the sheet of paper and can then be taped together to form a poster. See *Software section*.
- You can use preprinted forms and letterhead with plain paper. See *Software section*.



Save time and money

- To save paper, you can print multiple pages on one single sheet of paper.
- This machine automatically conserves electricity by substantially reducing power consumption when not in use.



Print in various environments

- You can print with Windows 2000 and Windows XP/2003/ Vista as well as Linux and Macintosh systems.
- Your machine is equipped with a USB interface and a network interface (CLP-310N, CLP-310W, CLP-315N, CLP-315W only).

FEATURES BY MODELS

The machine is designed to support all of your document needs – from printing, to more advanced networking solutions for your business. Basic features of this machine include;

FEATURES	CLP-310/CLP-315	CLP-310N/CLP-315N	CLP-310W/CLP-315W
USB 2.0	●	●	●
Network Interface 802.11b/g wireless LAN			●
Network Interface Ethernet 10/100 Base TX wired LAN		●	●
Duplex (2-sided) printing (Manual)	●	●	●

(●: Included, O: Optional, Blank: Not Available)



ABOUT THIS USER'S GUIDE

This user's guide provides information about basic understanding of the machine as well as detailed explanation on each step during the actual usage. Both novice users and professional users can refer to this guide for installing and using the machine.

Some terms in this guide are used interchangeably, as below:

- Document is synonymous with original.
- Paper is synonymous with media, or print media.

Following table offers the conventions of this guide:

CONVENTION	DESCRIPTION	EXAMPLE
Bold	Used for texts on the display or actual prints on the machine.	Start
Note	Used to provide additional information or detailed specification of the machine function and feature.	 The date format may differ from country to country
Caution	Used to give users information to protect the machine from possible mechanical damage or malfunction.	 Do not touch the green underside of the toner cartridge.
Footnote	Used to provide more detailed information on certain words or a phrase.	a. pages per minute
(See page 1 for more information)	Used to guide users to the reference page for the additional detailed information.	(See page 1 for more information)





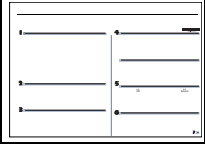
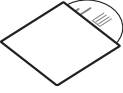
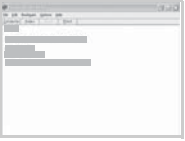





FINDING MORE INFORMATION

You can find information for setting up and using your machine from the following resources, either as a print-out or onscreen.















<p>Quick Install Guide</p> 	<p>Provides information on setting up your machine and this requires that you follow the instructions in the guide to prepare the machine.</p>
<p>Online User's Guide</p> 	<p>Provides you with step-by-step instructions for using your machine's full features, and contains information for maintaining your machine, troubleshooting, and installing accessories. This user's guide also contains a <i>Software section</i> to provide you with information on how to print documents with your machine in various operating systems, and how to use the included software utilities.</p> <p>Note You can access the user's guide in other languages from the Manual folder on the printer software CD.</p>
<p>Printer Driver Help</p> 	<p>Provides you with help information on printer driver properties and instructions for setting up the properties for printing. To access a printer driver help screen, click Help from the printer properties dialog box.</p>
<p>Samsung website</p>	<p>If you have Internet access, you can get help, support, printer drivers, manuals, and order information from the Samsung website, www.samsungprinter.com.</p>

IMPORTANT SAFETY SYMBOLS AND PRECAUTIONS

What the icons and signs in this user's guide mean:

 WARNING	Hazards or unsafe practices that may result in severe personal injury or death.
 CAUTION	Hazards or unsafe practices that may result in minor personal injury or property damage.
 CAUTION	To reduce the risk of fire, explosion, electric shock, or personal injury when using your laser MFP, follow these basic safety precautions:
	Do NOT attempt.
	Do NOT disassemble.
	Do NOT touch.
	Follow directions explicitly.
	Unplug the power plug from the wall socket.
	Make sure the MFP is grounded to prevent electric shock.
	Call the service center for help.

These warning signs are here to prevent injury to you and others. Follow them explicitly. After reading this section, keep it in a safe place for future reference.

-  1. Read and understand all instructions.
-  2. Use common sense whenever operating electrical appliances.
-  3. Follow all warnings and instructions marked on the machine and in the literature accompanying the machine.
-  4. If an operating instruction appears to conflict with safety information, heed the safety information. You may have misunderstood the operating instruction. If you cannot resolve the conflict, contact your sales or service representative for assistance.
-  5. Unplug the machine from the AC wall socket and/or telephone jack before cleaning. Do not use liquid or aerosol cleaners. Use only a damp cloth for cleaning.
-  6. Do not place the machine on an unstable cart, stand or table. It may fall, causing serious damage.
-  7. Your machine should never be placed on, near or over a radiator, heater, air conditioner or ventilation duct.
-  8. Do not allow anything to rest on the power. Do not locate your machine where the cords will be abused by persons walking on them.
-  9. Do not overload wall outlets and extension cords. This can diminish performance, and may result in the risk of fire or electric shock.
-  10. Do not allow pets to chew on the AC power, telephone or PC interface cords.
-  11. Never push objects of any kind into the machine through case or cabinet openings. They may touch dangerous voltage points, creating a risk of fire or shock. Never spill liquid of any kind onto or into the machine.
-    12. To reduce the risk of electric shock, do not disassemble the machine. Take it to a qualified service technician when repair work is required. Opening or removing covers may expose you to dangerous voltages or other risks. Incorrect reassembly could cause electric shock when the unit is subsequently used.



13. Unplug the machine from the telephone jack, PC and AC wall outlet and refer servicing to qualified service personnel under the following conditions:

- When any part of the power cord, plug or connecting cable is damaged or frayed.
- If liquid has been spilled into the machine.
- If the machine has been exposed to rain or water.
- If the machine does not operate properly after instructions have been followed.
- If the machine has been dropped, or the cabinet appears damaged.
- If the machine exhibits a sudden and distinct change in performance.



14. Adjust only those controls covered by the operating instructions. Improper adjustment of other controls may result in damage, and may require extensive work by a qualified service technician to restore the machine to normal operation.



15. Avoid using this machine during a lightning storm. There may be a remote risk of electric shock from lightning. If possible, unplug the AC power and telephone cord for the duration of the lightning storm.

16. The Power cord supplied with your machine should be used for safe operation. If you are using a cord which is longer than 2 m with 110 V machine, then it should be 16 AWG^a or bigger.

17. Use only No.26 AWG or larger telephone line cord.



18. SAVE THESE INSTRUCTIONS

a. AWG: American Wire Gauge

LASER SAFETY STATEMENT

The printer is certified in the U.S. to conform to the requirements of DHHS 21 CFR, chapter 1 Subchapter J for Class I(1) laser products, and elsewhere is certified as a Class I laser product conforming to the requirements of IEC 825.

Class I laser products are not considered to be hazardous. The laser system and printer are designed so there is never any human access to laser radiation above a Class I level during normal operation, user maintenance or prescribed service condition.

WARNING

Never operate or service the printer with the protective cover removed from Laser/Scanner assembly. The reflected beam, although invisible, can damage your eyes.

When using this product, these basic safety precautions should always be followed to reduce risk of fire, electric shock, and injury to persons:

	CAUTION - CLASS 3B LASER RADIATION WHEN OPEN AVOID EXPOSURE TO THE BEAM.
	DANGER - LASER RADIATION AVOID DIRECT EXPOSURE TO BEAM.
	DANGER - RADIATIONS INVISIBLES DU LASER EN CAS D'OUVERTURE. EVITER TOUTE EXPOSITION DIRECTE AU FASCEAU.
	VORSICHT - UNSICHTBARE LASERSTRAHLUNG, WENN ABDECKUNG GEÖFFNET. NICHT DEM STRAHL AUSSETZEN.
	ATTENZIONE - RADIAZIONE LASER INVISIBILE IN CASO DI APERTURA. EVITARE L'ESPOSIZIONE AL FASCIO.
	PRECAUCIÓN - RADIACIÓN LASER INVISIBLE CUANDO SE ABRE. EVITAR EXPONERSE AL RAYO.
	PERIGO - RADIÇÃO LASER INVISÍVEL AO ABRIR. EVITE EXPOSIÇÃO DIRECTA AO FEIXE.
	GEVAAR - ONZICHTBARE LASERSTRALEN BIJ GEOPENDE KLEP. DEZE KLEP NIET OPENEN.
	ADVARSEL - USYNLIG LASERSTRÅLNING VED ÅBNING. UNNGÅ UDSAETTELSE FOR STRÅLNING.
	ADVARSEL - USYNLIG LASERSTRÅLNING NÅR DEKSEL ÅPNES. UNNGÅ EKSPONERING FOR STRÅLEN.
VARNING - OSYNLIG LASERSTRÅLNING NÅR DENNA DEL ÅR ÖPPEN. STRÅLEN ÅR FARLIG.	
VAROITUS - NÄKYMÄTÖNTÄ LASERSÄTELYÄ AVATTAESSA. VARO SUORAA ALTISTUMISTA SÄTEELLE.	
注意 - 严禁揭开此盖, 以免激光泄露灼伤	
주의 - 이 덮개를 열면 레이저광에 노출될 수 있으므로 주의하십시오.	

OZONE SAFETY



During normal operation, this machine produces ozone. The ozone produced does not present a hazard to the operator. However, it is advisable that the machine be operated in a well ventilated area.
If you need additional information about ozone, request your nearest Samsung dealer.

MERCURY SAFETY



LAMP(S) INSIDE THIS PRODUCT CONTAIN MERCURY AND MUST BE RECYCLED OR DISPOSED OF ACCORDING TO LOCAL, STATE OR FEDERAL LAWS. For details see lamprecycle.org, eiae.org, or call 1-800-Samsung

POWER SAVER



This printer contains advanced energy conservation technology that reduces power consumption when it is not in active use. When the printer does not receive data for an extended period of time, power consumption is automatically lowered. ENERGY STAR and the ENERGY STAR mark are registered U.S. marks.
For more information on the ENERGY STAR program see <http://www.energystar.gov>

RECYCLING



Recycle or dispose of the packaging material for this product in an environmentally responsible manner.

CORRECT DISPOSAL OF THIS PRODUCT (WASTE ELECTRICAL & ELECTRONIC EQUIPMENT)



(Applicable in the European Union and other European countries with separate collection systems)

This marking shown on the product or its literature, indicates that it should not be disposed with other household wastes at the end of its working life. To prevent possible harm to the environment or human health from uncontrolled waste disposal, separate this from other types of wastes and recycle it responsibly to promote the sustainable reuse of material resources.

Household users should contact either the retailer where they purchased this product, or their local government office, for details of where and how they can take this item for environmentally safe recycling.

Business users should contact their supplier and check the terms and conditions of the purchase contract. This product should not be mixed with other commercial wastes for disposal.

RADIO FREQUENCY EMISSIONS

FCC Information to the User

This device complies with Part 15 of the FCC Rules. Operation is subject to the following two conditions:

- This device may not cause harmful interference, and
- This device must accept any interference received, including interference that may cause undesired operation.

This equipment has been tested and found to comply with the limits for a Class B digital device, pursuant to Part 15 of the FCC Rules. These limits are designed to provide reasonable protection against harmful interference in a residential installation. This equipment generates, uses and can radiate radio frequency energy and, if not installed and used in accordance with the instructions, may cause harmful interference to radio communications. However, there is no guarantee that interference will not occur in a particular installation. If this equipment does cause harmful interference to radio or television reception, which can be determined by turning the equipment off and on, the user is encouraged to try to correct the interference by one or more of the following measures:

- Reorient or relocate the receiving antenna.
- Increase the separation between the equipment and receiver.
- Connect the equipment into an outlet on a circuit different from that to which the receiver is connected.

- Consult the dealer or experienced radio TV technician for help.



Change or modifications not expressly approved by the manufacturer responsible for compliance could void the user's authority to operate the equipment.

Canadian Radio Interference Regulations

This digital apparatus does not exceed the Class B limits for radio noise emissions from digital apparatus as set out in the interference-causing equipment standard entitled "Digital Apparatus", ICES-003 of the Industry and Science Canada.

Cet appareil numérique respecte les limites de bruits radioélectriques applicables aux appareils numériques de Classe B prescrites dans la norme sur le matériel brouilleur: "Appareils Numériques", ICES-003 édictée par l'Industrie et Sciences Canada.

UNITED STATES OF AMERICA

Federal Communications Commission (FCC)

Intentional emitter per FCC Part 15

Low power, Radio LAN type devices (radio frequency (RF) wireless communication devices), operating in the 2.4 GHz/5 GHz Band, may be present (embedded) in your printer system. This section is only applicable if these devices are present. Refer to the system label to verify the presence of wireless devices.

Wireless devices that may be in your system are only qualified for use in the United States of America if an FCC ID number is on the system label.

The FCC has set a general guideline of 20 cm (8 inches) separation between the device and the body, for use of a wireless device near the body (this does not include extremities). This device should be used more than 20 cm (8 inches) from the body when wireless devices are on. The power output of the wireless device (or devices), which may be embedded in your printer, is well below the RF exposure limits as set by the FCC.

This transmitter must not be collocated or operation in conjunction with any other antenna or transmitter.

Operation of this device is subject to the following two conditions:(1) This device may not cause harmful interference, and(2) this device must accept any interference received, including interference that may cause undesired operation of the device.



Wireless devices are not user serviceable. Do not modify them in any way. Modification to a wireless device will void the authorization to use it. Contact manufacturer for service.



FCC Statement for Wireless LAN use:

While installing and operating this transmitter and antenna combination the radio frequency exposure limit of 1 mW/cm² may be exceeded at distances close to the antenna installed. Therefore, the user must maintain a minimum distance of 20cm from the antenna at all times. This device cannot be collocated with another transmitter and transmitting antenna.

FAX BRANDING

The Telephone Consumer Protection Act of 1991 makes it unlawful for any person to use a computer or other electronic device to send any message via a telephone facsimile machine unless such message clearly contains in a margin at the top or bottom of each transmitted page or on the first page of the transmission the following information:

- (1) the date and time of transmission
- (2) identification of either business, business entity or individual sending the message; and
- (3) telephone number of either the sending machine, business, business entity or individual.

The Telephone Company may make changes in its communications facilities, equipment operations or procedures where such action is reasonably required in the operation of its business and is not inconsistent with the rules and regulations in FCC Part 68. If such changes can be reasonably expected to render any customer terminal equipment incompatible with telephone company communications facilities, or require modification or alteration of such terminal equipment, or otherwise materially affect its use or performance, the customer shall be given adequate notice in writing, to allow the customer an opportunity to maintain uninterrupted service

RINGER EQUIVALENCE NUMBER

The Ringer Equivalence Number and FCC Registration Number for this machine may be found on the label located on the bottom or rear of the machine. In some instances you may need to provide these numbers to the telephone company.

The Ringer Equivalence Number (REN) is a measure of the electrical load placed on the telephone line, and is useful for determining whether you have “overloaded” the line. Installing several types of equipment on the same telephone line may result in problems making and receiving telephone calls, especially ringing when your line is called. The sum of all Ringer Equivalence Numbers of the equipment on your telephone line should be less than five in order to assure proper service from the telephone company. In some cases, a sum of five may not be usable on your line. If any of your telephone equipment is not operating properly, you should immediately remove it from your telephone line, as it may cause harm to the telephone network.



FCC Regulations state that changes or modifications to this equipment not expressly approved by the manufacturer could void the user's authority to operate this equipment. In the event that terminal equipment causes harm to the telephone network, the telephone company should notify the customer that service may be stopped. However, where prior notice is impractical, the company may temporarily cease service, providing that they:

- a) promptly notify the customer.
- b) give the customer an opportunity to correct the equipment problem.
- c) inform the customer of the right to bring a complaint to the Federal Communication Commission pursuant to procedures set out in FCC Rules and Regulations Subpart E of Part 68.

You should also know that:

- Your machine is not designed to be connected to a digital PBX system.
- If you intend to use a computer modem or fax modem on the same phone line as your machine, you may experience transmission and reception problems with all the equipment. It is recommended that no other equipment, except for a regular telephone, share the line with your machine.
- If your area experiences a high incidence of lightning or power surges, we recommend that you install surge protectors for both the power and the telephone lines. Surge protectors can be purchased from your dealer or telephone and electronic specialty stores.
- When programming emergency numbers and/or making test calls to emergency numbers, use a non-emergency number to advise the emergency service dispatcher of your intentions. The dispatcher will give you further instructions on how to actually test the emergency number.
- This machine may not be used on coin service or party lines.
- This machine provides magnetic coupling to hearing aids.

You may safely connect this equipment to the telephone network by means of a standard modular jack, USOC RJ-11C.

REPLACING THE FITTED PLUG (FOR UK ONLY)

Important

The mains lead for this machine is fitted with a standard (BS 1363) 13 amp plug and has a 13 amp fuse. When you change or examine the fuse, you must re-fit the correct 13 amp fuse. You then need to replace the fuse cover. If you have lost the fuse cover, do not use the plug until you have another fuse cover.

Contact the people from you purchased the machine.

The 13 amp plug is the most widely used type in the UK and should be suitable. However, some buildings (mainly old ones) do not have normal 13 amp plug sockets. You need to buy a suitable plug adaptor. Do not remove the moulded plug.



If you cut off the moulded plug, get rid of it straight away.

You cannot rewire the plug and you may receive an electric shock if you plug it into a socket.



Important warning:

You must earth this machine.

The wires in the mains lead have the following color code:

- Green and Yellow: Earth
- Blue: Neutral
- Brown: Live

If the wires in the mains lead do not match the colors marked in your plug, do the following:

You must connect the green and yellow wire to the pin marked by the letter “E” or by the safety ‘Earth symbol’ or colored green and yellow or green.

You must connect the blue wire to the pin which is marked with the letter “N” or colored black.

You must connect the brown wire to the pin which is marked with the letter “L” or colored red.

You must have a 13 amp fuse in the plug, adaptor, or at the distribution board.

DECLARATION OF CONFORMITY (EUROPEAN COUNTRIES)



Approvals and Certifications

The CE marking applied to this product symbolizes Samsung Electronics Co., Ltd. Declaration of Conformity with the following applicable 93/68/EEC Directives of the European Union as of the dates indicated:

January 1, 1995: Council Directive 73/23/EEC Approximation of the laws of the member states related to low voltage equipment.

January 1, 1996: Council Directive 89/336/EEC (92/31/EEC), approximation of the laws of the Member States related to electromagnetic compatibility.

March 9, 1999: Council Directive 1999/5/EC on radio equipment and telecommunications terminal equipment and the mutual recognition of their conformity. A full declaration, defining the relevant Directives and referenced standards can be obtained from your Samsung Electronics Co., Ltd. representative.

EC Certification

Certification to 1999/5/EC Radio Equipment & Telecommunications Terminal Equipment Directive (FAX)

This Samsung product has been self-certified by Samsung for pan-European single terminal connection to the analogue public switched telephone network (PSTN) in accordance with Directive 1999/5/EC. The product has been designed to work with the national PSTNs and compatible PBXs of the European countries:

In the event of problems, you should contact the Euro QA Lab of Samsung Electronics Co., Ltd. in the first instance.

The product has been tested against TBR21. To assist in the use and application of terminal equipment which complies with this standard, the European Telecommunication Standards Institute (ETSI) has issued an advisory document (EG 201 121) which contains notes and additional requirements to ensure network compatibility of TBR21 terminals. The product has been designed against, and is fully compliant with, all of the relevant advisory notes contained in this document.

European Radio Approval Information (for products fitted with EU-approved radio devices)

Low power, Radio LAN type devices (radio frequency (RF) wireless communication devices), operating in the 2.4 GHz/5 GHz band, may be present (embedded) in your printer system which is intended for home or office use. This section is only applicable if these devices are present. Refer to the system label to verify the presence of wireless devices.

Wireless devices that may be in your system are only qualified for use in the European Union or associated areas if a CE mark with **CE** a Notified Body Registration Number and the Alert Symbol is on the system label.

The power output of the wireless device or devices that may be embedded in your printer is well below the RF exposure limits as set by the European Commission through the R&TTE directive.

European States qualified under wireless approvals:

EU Austria, Belgium, Cyprus, Czech Republic, Denmark, Estonia, Finland, France (with frequency restrictions), Germany, Greece, Hungary, Ireland, Italy, Latvia, Lithuania, Luxembourg, Malta, The Netherlands, Poland, Portugal, Slovakia, Slovenia, Spain, Sweden and the U.K.

EEA/EFTA countries Iceland, Liechtenstein, Norway and Switzerland

European States with restrictions on use:

EU In France, the frequency range is restricted to 2446.5-2483.5 MHz for devices above 10 mW transmitting power such as wireless

EEA/EFTA countries No limitations at this time.

REGULATORY COMPLIANCE STATEMENTS

Wireless Guidance

Low power, Radio LAN type devices (radio frequency (RF) wireless communication devices), operating in the 2.4 GHz/5 GHz Band, may be present (embedded) in your printer system. The following section is a general overview of considerations while operating a wireless device.

Additional limitations, cautions, and concerns for specific countries are listed in the specific country sections (or country group sections). The wireless devices in your system are only qualified for use in the countries identified by the Radio Approval Marks on the system rating label. If the country you will be using the wireless device in, is not listed, contact your local Radio Approval agency for requirements. Wireless devices are closely regulated and use may not be allowed.

The power output of the wireless device or devices that may be embedded in your printer is well below the RF exposure limits as known at this time. Because the wireless devices (which may be embedded into your printer) emit less energy than is allowed in radio frequency safety standards and recommendations, manufacturer believes these devices are safe for use. Regardless of the power levels, care should be taken to minimize human contact during normal operation.

As a general guideline, a separation of 20 cm (8 inches) between the wireless device and the body, for use of a wireless device near the body (this does not include extremities) is typical. This device should be used more than 20 cm (8 inches) from the body when wireless devices are on and transmitting.

This transmitter must not be collocated or operation in conjunction with any other antenna or transmitter.

Some circumstances require restrictions on wireless devices. Examples of common restrictions are listed below:



Radio frequency wireless communication can interfere with equipment on commercial aircraft. Current aviation regulations require wireless devices to be turned off while traveling in an airplane. IEEE 802.11 (also known as wireless Ethernet) and Bluetooth communication devices are examples of devices that provide wireless communication.



In environments where the risk of interference to other devices or services is harmful or perceived as harmful, the option to use a wireless device may be restricted or eliminated. Airports, Hospitals, and Oxygen or flammable gas laden atmospheres are limited examples where use of wireless devices may be restricted or eliminated. When in environments where you are uncertain of the sanction to use wireless devices, ask the applicable authority for authorization prior to use or turning on the wireless device.



Every country has different restrictions on the use of wireless devices. Since your system is equipped with a wireless device, when traveling between countries with your system, check with the local Radio Approval authorities prior to any move or trip for any restrictions on the use of a wireless device in the destination country.



If your system came equipped with an internal embedded wireless device, do not operate the wireless device unless all covers and shields are in place and the system is fully assembled.



Wireless devices are not user serviceable. Do not modify them in any way. Modification to a wireless device will void the authorization to use it. Contact manufacturer for service.



Only use drivers approved for the country in which the device will be used. See the manufacturer System Restoration Kit, or contact manufacturer Technical Support for additional information.



ELECTRONICS

Declaration of Conformity

For the following product:

Manufactured at:

of Samsung Electronics Co., Ltd.
#259, Gongdan-Dong, Gumi-City, Gyeongsangbuk-Do, 730-030 Korea

of Samsung Electronics(Shandong) Digital Printing Co., Ltd.
264209, Samsung Road, Weihai Hi-Tech IDZ, Shandong Province, China

(Factory name, address)

We hereby declare, that the product above is in compliance with the essential requirements of the Low Voltage Directive (2006/95/EC) and EMC Directive (2004/108/EC) by application of:

EN60950-1:2001+A11:2004
EN55022:1998+A1:2000+A2:2003
EN61000-3-2:2000+A2:2005
EN61000-3-3:1995+A1:2001
EN55024:1998+A1:2001+A2:2003

The Technical documentation is kept at the below Manufacturer's address.

Manufacturer

Samsung Electronics Co., Ltd.
#259, Gongdan-Dong, Gumi-City
Gyungbuk, Korea 730-030

March 11,2008

Sung Hwan Baek / S. Manager

Representative in the EU:

Samsung Electronics Euro QA Lab.
Blackbushe Business Park
Saxony Way, Yateley, Hampshire
GU46 6GG, UK

March 11,2008

(Place and date of issue)

Yong Sang Park / S. Manager

(Name and signature of authorized person)

		2	Features of your new laser product
		5	Safety information
		16	Printer overview
		16	Front view
		16	Rear view
		17	Control panel overview
		18	Understanding the control panel
		18	LEDs
		18	Stop button
		19	Supplied software
		19	Printer driver features
		19	Printer driver
		20	Setting up the hardware
		20	Printing a demo page
		20	System requirements
		20	Windows
		21	Macintosh
		21	Linux
		21	Setting up the network
		21	Supported operating systems
		21	Using SetIP program
		22	Configuring wireless network from syncthru web service
		23	Installing the software
		24	Machine's basic settings
		24	Altitude adjustment
		24	Using the save modes
		24	Auto continue
		25	Selecting print media
		26	Specifications on print media
		27	Guidelines for special print media
		28	Changing the size of the paper in the paper tray
		30	Printing on special print materials
		30	Adjusting the output support
		30	Setting the paper size and type
		31	Printing a document
		31	Canceling a print job
		32	Printing reports
		32	Cleaning your machine
		32	Cleaning the outside
		32	Cleaning the inside
		34	Maintaining the cartridge
		34	Toner cartridge storage
		34	Expected cartridge life
		34	Redistributing toner
		35	Replacing the toner cartridge
		36	Replacing the Imaging Unit

contents

	37	Replacing the waste toner container
	38	Maintenance parts
	38	Managing your machine from the website
	38	To access SyncThru™ Web Service:
TROUBLESHOOTING	39	Tips for avoiding paper jams
	39	Clearing paper jams
	41	Solving other problems
	41	Paper feeding
	41	Printing problems
	42	Printing quality problems
	45	Common Windows problems
	45	Common Linux problems
	46	Common Macintosh problems
ORDERING SUPPLIES AND ACCESSORIES	47	Supplies
	47	How to purchase
SPECIFICATIONS	48	General specifications
	49	Printer specifications
GLOSSARY	50	
INDEX	54	
CONTACT SAMSUNG WORLDWIDE	55	

introduction

These are the main components of your machine:

This chapter includes:

- Printer overview
- Control panel overview
- Understanding the control panel
- Supplied software
- Printer driver features

PRINTER OVERVIEW

Front view

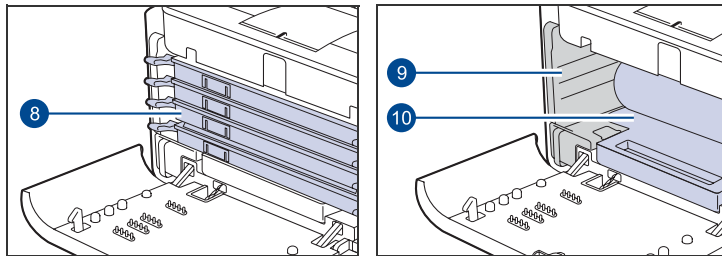
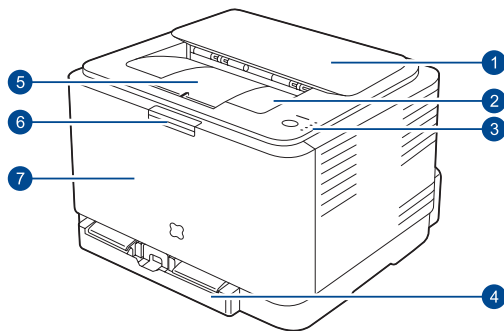

1	Top cover
2	Output tray (face down)
3	Control panel
4	Tray
5	Output support
6	Front cover release button
7	Front cover
8	Toner cartridge
9	Waste toner container
10	Imaging unit

Rear view

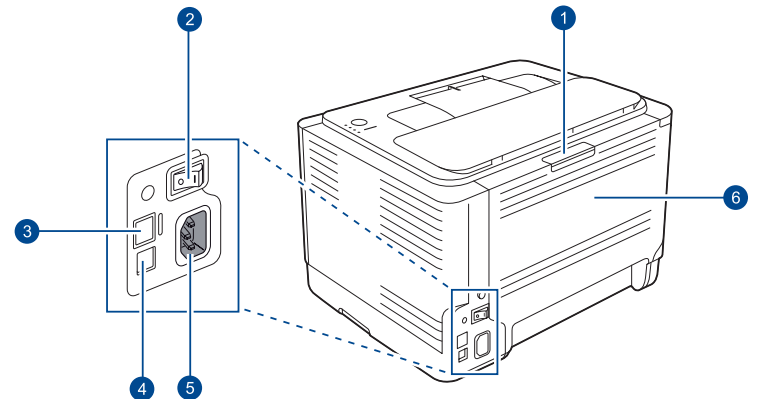

1	Rear cover release button
2	Power switch
3	Network port ^a
4	USB port
5	Power receptacle
6	Rear cover

a. CLP-310N, CLP-310W, CLP-315N, CLP-315W only.

CONTROL PANEL OVERVIEW

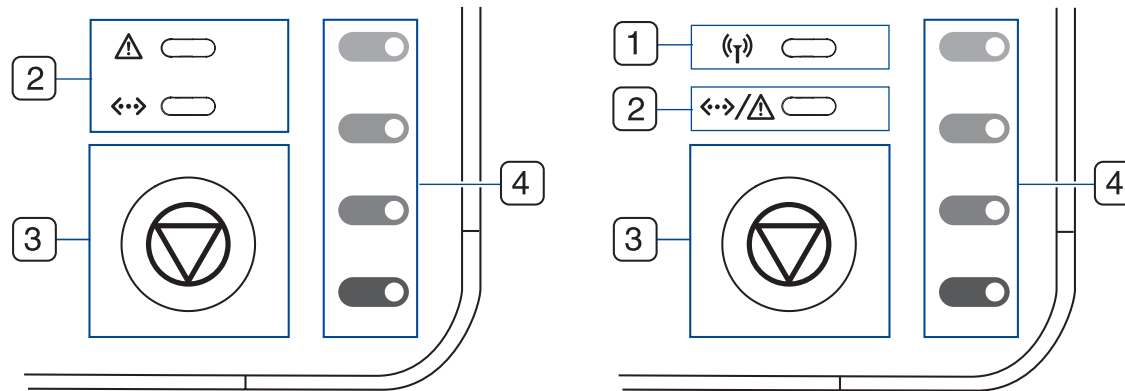

1	wireless LED	Shows the status of wireless network. When the LED on, the machine is ready. (Wireless models only)
2	status LED	Shows the status of your machine. (See "Understanding the control panel" on page 18 for more information.)
3	stop	Stops an operation at any time and there are more functions. (See "Understanding the control panel" on page 18 for more information.)
4	toner colors	Show the status of each toner cartridge. See Status LED with the toner cartridge messages on page 18.

UNDERSTANDING THE CONTROL PANEL

The color of the status and toner colors LED indicates the machine's current status.

LEDs

STATUS LED	TONER COLORS LED	DESCRIPTION
lights green	all LEDs off	The machine is ready to print.
slowly blinks green	all LEDs off	The machine is receiving data from the computer.
fast blinks green	all LEDs off	The machine is printing data.
lights red	all LEDs off	<ul style="list-style-type: none">The machine is experiencing an error, such as open cover, empty paper, not installed waste toner container, or full waste toner container.The machine is experiencing a service required error, such as LSU error, fuser error, or ITB error, Contact your sales or service representative.
lights orange	all LEDs off	<ul style="list-style-type: none">The machine is experiencing an error such as jammed paper.While the machine is booting up, do not open a top cover, since the machine may treat it as an error such as paper jam. In this case, open a front cover and close it then, the machine will reboot up.
lights green	each LED blinks red	Each toner cartridge is near the end of its life.
blinks red	each LED lights red	Each toner cartridge is almost empty. You can print, but the quality is not reliable.
lights red	each LED lights red	<ul style="list-style-type: none">Each toner cartridge is totally exhausted. You can not print.Each toner cartridge is wrong.
lights green	each LED blinks red in a repeated order	The machine is warming up.

 All printing errors will be appear in the **Smart Panel** program window.

Stop button

STATUS LED	DESCRIPTION
Printing demo page	In Ready mode, press and hold this button for about 2 seconds until the status LED blinks slowly, and release.
Printing configuration sheets	In Ready mode, press and hold this button for about 5 seconds until the status LED blinks fast, and release.
Canceling print job	Press this button during printing. The red LED blinks while the print job is cleared from both the machine and the computer, and then the machine returns to ready mode. This may take some time depending on the size of the print job.

SUPPLIED SOFTWARE

You must install the printer software using the supplied CD after you have set up your machine and connected it to your computer. CD provides you with the following software.

CD	CONTENTS	
Printer software CD	Windows	<ul style="list-style-type: none"> • Printer driver: Use this driver to take full advantage of your printer's features. • Smart Panel: This program allows you to monitor the machine's status and alerts you when an error occurs during printing. • SetIP: Use this program to set your machine's TCP/IP addresses. (CLP-310N, CLP-310W, CLP-315N, CLP-315W only).
	Linux	<ul style="list-style-type: none"> • Printer driver: Use this driver to run your machine from a Linux computer and print documents. • Smart Panel: This program allows you to monitor the machine's status and alerts you when an error occurs during printing.
	Macintosh	<ul style="list-style-type: none"> • Printer driver: Use this driver to run your machine from a Macintosh computer and print documents. • Smart Panel: This program allows you to monitor the machine's status and alerts you when an error occurs during printing.

PRINTER DRIVER FEATURES

Your printer drivers support the following standard features:

- Paper orientation, size, source and media type selection
- Number of copies

In addition, you can use various special printing features. The following table shows a general overview of features supported by your printer drivers:

 Some models or operating system may not support the certain feature(s) in the following table.

Printer driver

FEATURE	WINDOWS	LINUX	MACINTOSH
Color mode	O	O	O
Machine quality option	O	O	O
Poster printing	O	X	X
Multiple pages per sheet (N-up)	O	O (2, 4)	O
Fit to page printing	O	X	O
Scale printing	O	X	O
Watermark	O	X	X
Overlay	O	X	X
Duplex (Manual)	O	X	X

getting started

This chapter gives you step-by-step instructions for setting up the machine.

This chapter includes:

- Setting up the hardware
- Printing a demo page
- System requirements
- Setting up the network

SETTING UP THE HARDWARE

This section shows the steps to set up the hardware which is explained in the *Quick Install Guide*. Make sure you read *Quick Install Guide* and complete following steps.

1. Select a stable location.

Select a level, stable place with adequate space for air circulation. Allow extra space to open covers and trays.

The area should be well-ventilated and away from direct sunlight or sources of heat, cold, and humidity. Do not set the machine close to the edge of your desk or table.

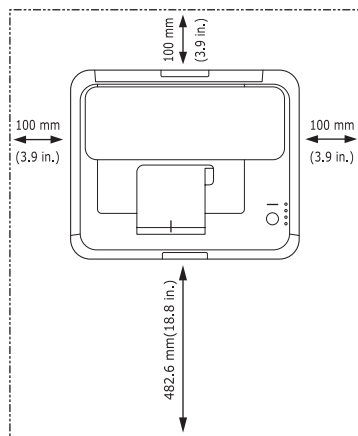

Printing is suitable for altitudes under 1,000 m (3,281 ft). Refer to the altitude setting to optimize your printing. See "Altitude adjustment" on page 24 for more information.

Place the machine on a flat and stable surface, not letting it lean more than 2 mm (0.08 inches). Otherwise, it may affect the printing quality.

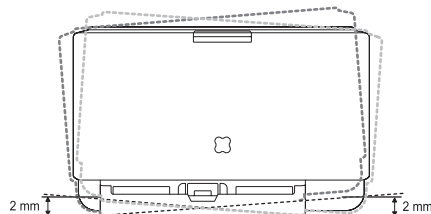

2. Unpack the machine and check all the enclosed items.
3. Remove the tape holding the machine tightly.

- Configuring wireless network from synctru web service
- Installing the software
- Machine's basic settings

4. Load paper. (See "Changing the size of the paper in the paper tray" on page 28.)
5. Make sure that all the cables are connected to the machine.
6. Turn the machine on.

 When you move the machine, do not tilt or turn it upside down. Otherwise, the inside of the machine may be contaminated by toner, which can cause damage to the machine or bad print quality.

PRINTING A DEMO PAGE

Print a demo page to make sure that the machine is operating correctly. To print a demo page:

In ready mode, press and hold the  **Stop** button for about 2 seconds.

SYSTEM REQUIREMENTS

Before you begin, ensure that your system meets the following requirements:

Windows

Your machine supports the following Windows operating systems.

OPERATING SYSTEM	REQUIREMENT (RECOMMENDED)		
	CPU	RAM	FREE HDD SPACE
Windows 2000	Pentium II 400 MHz (Pentium III 933 MHz)	128 MB (256 MB)	600 MB
Windows XP	Pentium III 933 MHz (Pentium IV 1 GHz)	128 MB (256 MB)	1.5 GB
Windows 2003 Server	Pentium III 933 MHz (Pentium IV 1 GHz)	128 MB (512 MB)	1.25 GB to 2 GB
Windows Vista	Pentium IV 3 GHz	512 MB (1024 MB)	15 GB

-  Internet Explorer 6.0 or higher is the minimum requirement for all Windows operating systems.
- Users who have an administrator right can install the software.

Macintosh

OPERATING SYSTEM	REQUIREMENT (RECOMMENDED)		
	CPU	RAM	FREE HDD SPACE
Mac OS X 10.3 ~ 10.4	<ul style="list-style-type: none"> Intel Processor Power PC G4 / G5 	<ul style="list-style-type: none"> 128 MB for a Power-PC based Mac (512 MB). 512 MB for an Intel-based Mac (1 GB) 	1 GB
Mac OS X 10.5	<ul style="list-style-type: none"> Intel Processor 867 MHz or faster Power PC G4 /G5 	512 MB (1 GB)	1 GB

Linux

ITEM	REQUIREMENTS
Operating system	RedHat 8.0, 9.0 (32bit) RedHat Enterprise Linux WS 4, 5 (32/64bit) Fedora Core 1~7 (32/64bit) Mandrake 9.2 (32bit), 10.0, 10.1 (32/64bit) Mandriva 2005, 2006, 2007 (32/64bit) SuSE Linux 8.2, 9.0, 9.1 (32bit) SuSE Linux 9.2, 9.3, 10.0, 10.1, 10.2 (32/64bit) SuSE Linux Enterprise Desktop 9, 10 (32/64bit) Ubuntu 6.06, 6.10, 7.04 (32/64bit) Debian 3.1, 4.0 (32/64bit)
CPU	Pentium IV 2.4GHz (IntelCore2)
RAM	512 MB (1024 MB)
Free HDD space	1 GB (2GB)

SETTING UP THE NETWORK

If your machine is connected to a network, you need to set up the network protocols on the machine to use it as your network printer.

Supported operating systems

The following table shows the network environments supported by the machine:

ITEM	REQUIREMENTS
Network interface	<ul style="list-style-type: none"> Ethernet 10/100 Base-TX (CLP-310N, CLP-310W, CLP-315N, CLP-315W only) IEEE 802.11 b/g Wireless LAN (CLP-310W, CLP-315W only)
Network operating system	<ul style="list-style-type: none"> Windows 2000/XP/2003/Vista Various Linux OS Mac OS 10.3 ~ 10.5

ITEM	REQUIREMENTS
Network protocols	<ul style="list-style-type: none"> TCP/IP Standard TCP/IP LPR IPP/HTTP Bonjour DHCP BOOTP

Using SetIP program



This program is for the network IP setting using the MAC address which is the hardware serial number of the network printer card or interface. Especially, it is for the network administrator to set several network IPs at the same time.

-  You can only use SetIP program when your machine is connected to a network.
- The following procedure is based on the Windows XP operating system.
- If you are in a non-static IP address environment and need to setup a DHCP network protocol, go to the <http://developer.apple.com/networking/bonjour/download/>, select the program Bonjour for Windows due to your computer operating system, and install the program. This program will allow you to fix the network parameter automatically. Follow the instruction in the installation window. This program does not support Linux.

Installing the program

- Insert the driver CD provided along with your machine. When the driver CD runs automatically, close the window.
- Start **Windows Explorer** and open the X drive. (X represents your CD-ROM drive.)
- Double click **Application > SetIP**.
- Open the folder of the language you plan to use.
- Double click **Setup.exe** to install this program.
- Follow the instruction on the window to complete the installation.

Starting the program

- Print the machine's network information report which includes your machine's MAC address. To print the report, you need to press and hold  **Stop** for about 5 seconds.
- From the Windows **Start** menu, select **All Programs > Samsung Network Printer Utilities > SetIP > SetIP**.
- Click  in the SetIP window to open the TCP/IP configuration window.
- Enter the network card's MAC address, IP address, subnet mask, default gateway, and then click **Apply**.
 When you enter the MAC address, enter it without colon(:).
- Click **OK**, then the machine prints the network information. Confirm all the settings are correct.
- Click **Exit** to close the **SetIP** program.

 Contact the network administrator if you are not sure how to configure.

 You can also set up the network settings through the network administration programs.

- **SyncThru™ Web Admin Service:** Web-based printer management solution for network administrators. **SyncThru™ Web Admin Service** provides you with an efficient way of managing network devices and lets you remotely monitor and troubleshoot network machines from any site with corporate internet access. Download this program from <http://solution.samsungprinter.com>.
- **SyncThru™ Web Service:** Web server embedded on your network print server, which allows you to:
 - Configure the network parameters necessary for the machine to connect to various network environments.
 - Customize machine settings.
- **SetIP:** Utility program allowing you to select a network interface and manually configure the IP addresses for use with the TCP/IP protocol. (See "Using SetIP program" on page 21.)

 CLP-310W, CLP-315W can be used in wireless network environments. (See "Configuring wireless network from syncthru web service" on page 22.)

CONFIGURING WIRELESS NETWORK FROM SYNCTHRU WEB SERVICE

You must configure the appropriate network parameters to use your printer in a wireless network. You can use **SyncThru™ Web Service**, an embedded web site of your printer. This section gives you basic information on 802.11b/g network parameters which can be configured from the **SyncThru™ Web Service**.

You can configure basic wireless settings, such as **SSID**, **Operation Mode** and **WPA Shared Key**. You can retrieve basic settings by selecting a wireless network.

If you do not know about your wireless environment, please ask the network administrator.

 Before wireless network settings, your machine must have an IP address. See "Using SetIP program" on page 21.

1. Enter your machine's IP address as the URL in a browser and click **Go** to access the web site of your machine.
2. Click **Network Settings** and **Wireless**.
3. Select **Wizard** in **Wireless Settings**.

 If you want to set wireless network directly, select **Custom**.

4. Click **Next**.

5. Select **Network Name(SSID)** in **SSID Setup**.

- **SSID:** SSID(Service Set Identifier) is a name that identifies a wireless network. Access points and wireless devices attempting to connect to a specific wireless network must use the same SSID. The SSID is case-sensitive.
- **Operation Mode:** Operation Mode refers to the type of wireless connections.
 - **Ad-hoc:** allows wireless devices to communicate directly with each other in a peer-to-peer environment.
 - **Infrastructure:** allows wireless devices to communicate with each other through an access point.

6. Click **Next**.

If wireless security setting window appears, enter the registered password and click **Next**.

• **Operation Mode is Infrastructure:**

- **None:** This is used when the validation of a wireless device's identity and data encryption are not required for your network. Open system is used for IEEE 802.11 authentication.

- **Static WEP:** This uses the WEP (Wired Equivalent Privacy) algorithm suggested by IEEE 802.11 standard for security. Static WEP security mode requires a proper WEP key for data encryption, decryption, and IEEE 802.11 authentication.

- **WPA Personal:** You can select WPA-PSK to authenticate the print server based on WPA Pre-Shared Key. This uses a shared secret key (generally called Pre Shared Key passphrase) that is manually configured on the access point and each of its clients. This is suitable for users who want to use WPA but do not have a RADIUS server installed on their network.

• **Operation Mode is Ad-hoc:**

- **None:** This is used when the validation of a wireless device's identity and data encryption are not required for your network. Open system is used for IEEE 802.11 authentication.

- **Static WEP:** This uses the WEP (Wired Equivalent Privacy) algorithm suggested by IEEE 802.11 standard for security. Static WEP security mode requires a proper WEP key for data encryption, decryption, and IEEE 802.11 authentication.

7. **Wizard Setup Confirmation** window appears, please check your wireless setup. If the setup is right, click **Apply**.

8. Click **OK**.

 If **Operation Mode of Network Name(SSID)** is **Infrastructure**, you must disconnect the network cable to activate wireless network after completing the network setting.

INSTALLING THE SOFTWARE

You have to install the machine software for printing. The software includes drivers, applications, and other user friendly programs. The following procedure is based on Windows XP. If you use Macintosh or Linux OS, see Software section.

- The following procedure is for the machine with the network feature. If you want to connect a machine with a USB cable, refer to the *Quick Install Guide* or *Software section*.
- The following procedure is based on the Windows XP operating system. The procedure and popup window which appear during the installation may differ depending on the operating system, the printer feature, or the interface in use.

1. Connect the network cable to your machine.
2. Make sure that the network setup for your machine is completed. (See "Setting up the network" on page 21.) All applications should be closed on your computer before beginning installation.
3. Insert the Printer Software CD-ROM into your CD-ROM drive. The CD-ROM should automatically run, and an installation window appears. If the installation window does not appear, click **Start > Run**. Type X:\Setup.exe, replacing "X" with the letter which represents your drive and click **OK**. If you use Windows Vista, click **Start > All Programs > Accessories > Run**, and type X:\Setup.exe. If the **AutoPlay** window appears in Windows Vista, click **Run Setup.exe** in **Install or run program** field, and click **Continue** in the **User Account Control** window.
4. Click **Next**.

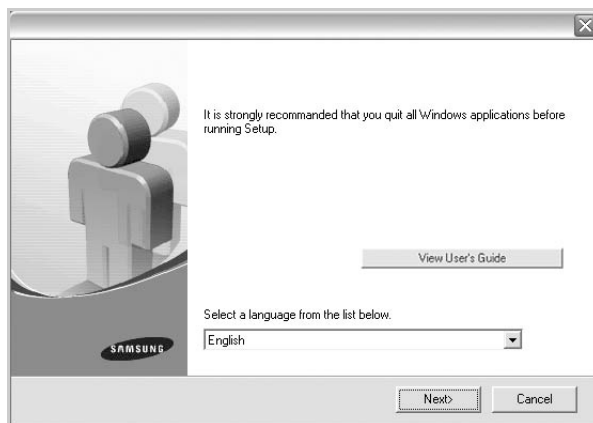

- The window above may slightly differ, if you are reinstalling the driver.
- **View User's Guide:** Allows you to view the User's Guide. If your computer does not have Adobe Acrobat, clicking on this button will automatically install Adobe Acrobat Reader for you, and then open the User's Guide.

5. Select **Typical installation for a network printer**, and then click **Next**.

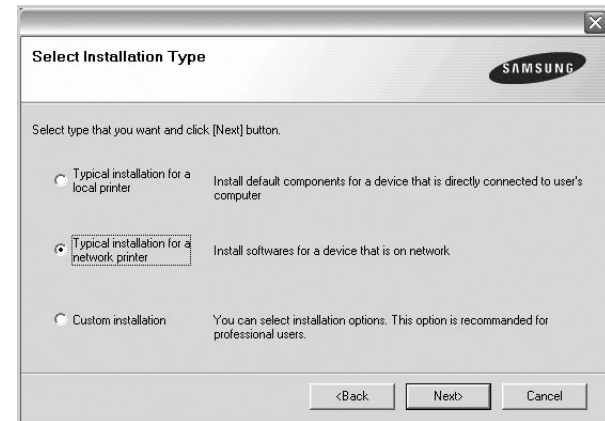

6. The list of machines available on the network appears. Select the printer you want to install from the list and then click **Next**.

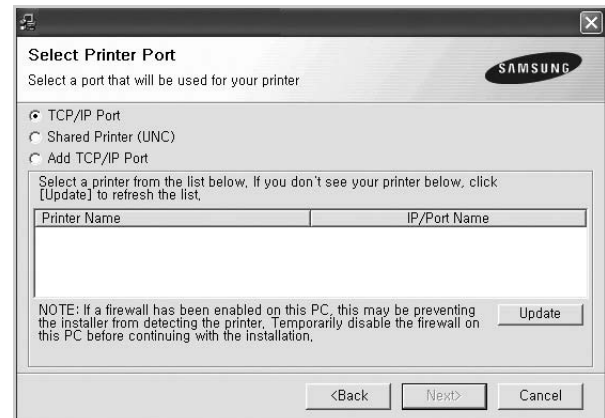

- If you do not see your machine on the list, click **Update** to refresh the list, or select **Add TCP/IP Port** to add your machine to the network. To add the machine to the network, enter the port name and the IP address for the machine. To verify your machine's IP address or the MAC address, print a Network Configuration page.
 - To find a shared network printer (UNC Path), select **Shared Printer [UNC]** and enter the shared name manually or find a shared printer by clicking the **Browse** button.
7. After the installation is finished, a window appears asking you to print a test page and to register yourself as a user of Samsung machines in order to receive information from Samsung. If you wish to do so, select the corresponding checkbox(es) and click **Finish**.

- If you are not sure of the IP address, contact your network administrator or print network information.

- If your machine does not work properly after the installation, try to reinstall the printer driver. See *Software section*.
- During the printer driver installation process, the driver installer detects the location information for your operating system and sets the default paper size for your machine. If you use a different Windows location, you must change the paper size to match the paper you usually use. Go to printer properties to change the paper size after installation is complete.

MACHINE'S BASIC SETTINGS

After installation is complete, you may want to set the machine's default settings. Refer to the next section if you would like to set or change values.

Altitude adjustment

The print quality is affected by atmospheric pressure, which is determined by the height of the machine above sea level. The following information will guide you on how to set your machine to the best print quality or best quality of print.

Before you set the altitude value, find the altitude where you are using the machine.

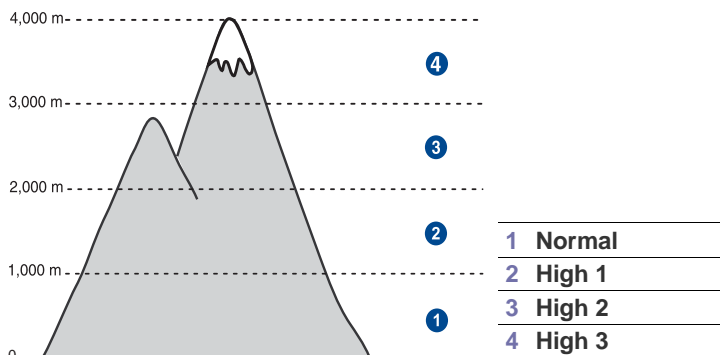

1. Ensure that you have installed the printer driver with the provided Printer Software CD.
2. Double-click the **Smart Panel** icon on the Windows task bar (or Notification Area in Linux). You can also click **Smart Panel** on the status bar in Mac OS X.
3. Click **Printer Setting**.
4. Click **Setting > Altitude Adjustment**. Select the appropriate value from the dropdown list, and then click **Apply**.

 If your machine is connected to a network, **SyncThru™ Web Service** screen appears automatically. Click **Machine Settings > Setup (or Machine Setup) > Altitude**. Select the appropriate altitude value, and then click **Apply**.

Using the save modes

Power Save mode

Power Save mode allows your machine to reduce power consumption when it is not in actual use. You can turn this mode on and select a length of time for which the machine waits after a job is printed before it switches to a reduced power state.

1. Ensure that you have installed the printer driver with the provided Printer Software CD.
2. Double-click the **Smart Panel** icon on the Windows task bar (or Notification Area in Linux). You can also click **Smart Panel** on the status bar in Mac OS X.
3. Click **Printer Setting**.
4. Click **Setting > Power Save**. Select the appropriate value from the dropdown list, and then click **Apply**.

 If your machine is connected to a network, **SyncThru™ Web Service** screen appears automatically. Click **Machine Settings > Setup (or Machine Setup) > Power Save**. Select the appropriate altitude value, and then click **Apply**.

Auto continue

This is the option to set the machine to continue printing or not, in case the paper size you have set and the paper within the tray mismatches.

1. Ensure that you have installed the printer driver with the provided Printer Software CD.
2. Double-click the **Smart Panel** icon on the Windows task bar (or Notification Area in Linux). You can also click **Smart Panel** on the status bar in Mac OS X.
3. Click **Printer Setting**.
4. Click **Setting > Auto Continue**. Select the appropriate value from the dropdown list, and then click **Apply**.

 If your machine is connected to a network, **SyncThru™ Web Service** screen appears automatically. Click **Machine Settings > Setup (or Machine Setup) > Auto Continue**. Select the appropriate altitude value, and then click **Apply**.

selecting and loading print media

This chapter introduces you how to load originals and print media into your machine.

This chapter includes:

- Selecting print media
- Changing the size of the paper in the paper tray
- Printing on special print materials
- Adjusting the output support
- Setting the paper size and type

SELECTING PRINT MEDIA

You can print on a variety of print media, such as plain paper, envelopes, labels, and transparencies. Always use print media that meet the guidelines for use with your machine. Print media that does not meet the guidelines outlined in this user's guide may cause the following problems:

- Poor print quality
- Increased paper jams
- Premature wear on the machine.

Properties, such as weight, composition, grain, and moisture content, are important factors that affect the machine's performance and the output quality. When you choose print materials, consider the following:

- The type, size and weight of the print media for your machine are described later in this section.
- Desired outcome: The print media you choose should be appropriate for your project.
- Brightness: Some print media are whiter than others and produce sharper, more vibrant images.
- Surface smoothness: The smoothness of the print media affects how crisp the printing looks on the paper.



- Some print media may meet all of the guidelines in this section and still not produce satisfactory results. This may be the result of improper handling, unacceptable temperature and humidity levels, or other variables over which Samsung has no control.
- Before purchasing large quantities of print media, ensure that it meets the requirements specified in this user's guide.



Using print media that does not meet these specifications may cause problems, requiring repairs. Such repairs are not covered by Samsung's warranty or service agreements.



Make sure not to use the inkjet photo paper with this machine. It could cause damage to the machine.

Specifications on print media

TYPE	SIZE	DIMENSIONS	WEIGHT ^A	CAPACITY ^B
Plain paper	Letter	216 x 279 mm (8.5 x 11 inches)	<ul style="list-style-type: none"> 60 to 105 g/m² (16 to 28 lb bond) 60 to 163 g/m² (16 to 43 lb bond) 	<ul style="list-style-type: none"> 150 sheets of 75 g/m² (20 lb bond) paper for the tray 1 sheet for manual feeding in the tray
	Legal	216 x 356 mm (8.5 x 14 inches)		
	Folio	216 x 330 mm (8.5 x 13 inches)		
	A4	210 x 297 mm (8.26 x 11.69 inches)		
	Oficio	216 x 343 mm (8.5 x 13.5 inches)		
	JIS B5	182 x 257 mm (7.16 x 10.11 inches)		
	ISO B5	176 x 250 mm (6.93 x 9.84 inches)		
	Executive	184 x 267 mm (7.25 x 10.5 inches)		
	Statement	140 x 216 mm (5.50 x 8.50 inches)		
	A5	148 x 210 mm (5.82 x 8.26 inches)		
	A6	105 x 148 mm (4.13 x 5.82 inches)		
Envelope	Monarch	98 x 191 mm (3.87 x 7.5 inches)	75 to 90 g/m ² (20 to 24 lb bond)	5 sheets for manual feeding in the tray
	No. 10	105 x 241 mm (4.12 x 9.5 inches)		
	DL	110 x 220 mm (4.33 x 8.66 inches)		
	C5	162 x 229 mm (6.37 x 9.01 inches)		
	C6	114 x 162 mm (4.48 x 6.38 inches)		
	No.9	98 x 225 mm (3.87 x 8.87 inches)		
	6 3/4	92 x 165 mm (3.62 x 6.5 inches)		
Thick paper	Refer to the Plain paper section	Refer to the Plain paper section	90 to 105 g/m ² (24 to 28 lb bond)	
Thin paper	Refer to the Plain paper section	Refer to the Plain paper section	60 to 70 g/m ² (16 to 19 lb bond)	
Labels ^c	Letter, A4	Refer to the Plain paper section	120 to 150 g/m ² (32 to 40 lb bond)	
Card stock	Post card	101.6 x 152.4 mm (4 x 6 inches)	105 to 163 g/m ² (28 to 43 lb bond)	
Transparency ^d	Letter, A4	Refer to the Plain paper section	138 to 146 g/m ² (37 to 39 lb bond)	1 sheet for manual feeding in the tray
Glossy paper	Letter ^e , A4 ^f	Refer to the Plain paper section	160 g/m ² (44 lb bond)	
Minimum size (custom)		76 x 160 mm (3 x 6.3 inches)	60 to 163 g/m ² (16 to 43 lb bond)	
Maximum size (custom)		216 x 356 mm (8.5 x 14 inches)		

a. If media weight is over 105 g/m² (28 lb bond), load a paper into the tray one by one.

b. Maximum capacity may differ depending on media weight, thickness, and environmental conditions.

c. Smoothness: 100 to 250 (sheffield)

d. Recommended media: Transparency for a color laser printer by Xerox such as 3R 91331(A4), 3R 2780(Letter).

e. Recommended media: Glossy paper (Letter) for this machine by **HP Brochure Paper** (Product: Q6611A) only.

f. Recommended media: Glossy paper (A4) for this machine by **HP Superior Paper 160 glossy** (Product: Q6616A) only.

Guidelines for special print media

MEDIA TYPE	GUIDELINES
Envelopes	<ul style="list-style-type: none"> Successful printing on envelopes depends upon the quality of the envelopes. When selecting envelopes, consider the following factors: <ul style="list-style-type: none"> Weight: The weight of the envelope paper should not exceed 90 g/m² or jamming may occur. Construction: Prior to printing, envelopes should lie flat with less than 6 mm curl, and should not contain air. Condition: Envelopes should not be wrinkled, nicked, or otherwise damaged. Temperature: You should use envelopes that are compatible with the heat and pressure of the machine during operation. Use only well-constructed envelopes with sharp and well creased folds. Do not use stamped envelopes. Do not use envelopes with clasps, snaps, windows, coated lining, self-adhesive seals, or other synthetic materials. Do not use damaged or poorly made envelopes. Be sure the seam at both ends of the envelope extends all the way to the corner of the envelope. <div data-bbox="459 826 772 1081" style="text-align: center;"> <p>1 Acceptable 2 Unacceptable</p> </div> <ul style="list-style-type: none"> Envelopes with a peel-off adhesive strip or with more than one flap that folds over to seal must use adhesives compatible with the machine's fusing temperature for 0.1 second. Check your machine's specification to view the fusing temperature, see page 48. The extra flaps and strips might cause wrinkling, creasing, or jams, and may even damage the fuser. For the best print quality, position margins no closer than 15 mm from the edges of the envelope. Avoid printing over the area where the envelope's seams meet.

MEDIA TYPE	GUIDELINES
Labels	<ul style="list-style-type: none"> To avoid damaging the machine, use only labels designed for use in laser machines. <ul style="list-style-type: none"> When selecting labels, consider the following factors: <ul style="list-style-type: none"> Adhesives: The adhesive material should be stable at your machine's fusing temperature. Check your machine's specification to view the fusing temperature, see page 48. Arrangement: Only use labels with no exposed backing between them. Labels can peel off sheets that have spaces between the labels, causing serious jams. Curl: Prior to printing, labels must lie flat with no more than 13 mm of curl in any direction. Condition: Do not use labels with wrinkles, bubbles, or other indications of separation. Make sure that there is no exposed adhesive material between labels. Exposed areas can cause labels to peel off during printing, which can cause paper jams. Exposed adhesive can also cause damage to machine components. Do not run a sheet of labels through the machine more than once. The adhesive backing is designed for only a single pass through the machine. Do not use labels that are separating from the backing sheet or are wrinkled, bubbled, or otherwise damaged.
Card stock or custom-sized materials	<ul style="list-style-type: none"> Do not print on media smaller than 76 mm wide or 356 mm long. In the software application, set margins at least 6.4 mm away from the edges of the material.
Preprinted paper	<ul style="list-style-type: none"> Letterhead must be printed with heat-resistant ink that will not melt, vaporize, or release hazardous emissions when subjected to the printer's fusing temperature for 0.1 second. Check your machine's specification to view the fusing temperature, see page 48. Letterhead ink must be non-flammable and should not adversely affect printer rollers. Forms and letterhead should be sealed in a moisture-proof wrapping to prevent changes during storage. Before you load preprinted paper, such as forms and letterhead, verify that the ink on the paper is dry. During the fusing process, wet ink can come off preprinted paper, reducing print quality.



Using photographic paper or coated paper may cause problems, requiring repairs. Such repairs are not covered by Samsung's warranty or service agreements.

CHANGING THE SIZE OF THE PAPER IN THE PAPER TRAY

To load different sizes of paper, such as Legal-sized paper, you need to adjust the paper guides to extend the paper tray. To change the tray size to other size, you must adjust the paper length guide properly.

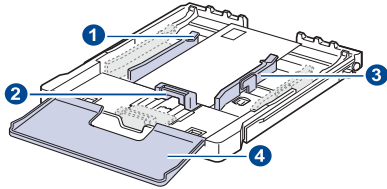

- 1 Tray extend lever
- 2 Paper length guide
- 3 Paper width guide
- 4 Paper cover

1. Pull the tray out of the machine. Open the paper cover and remove paper from the tray if necessary.

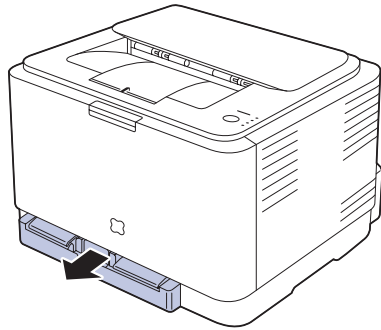

2. Pressing and unlatching the guide lock in the top of the tray, pull the tray out manually.

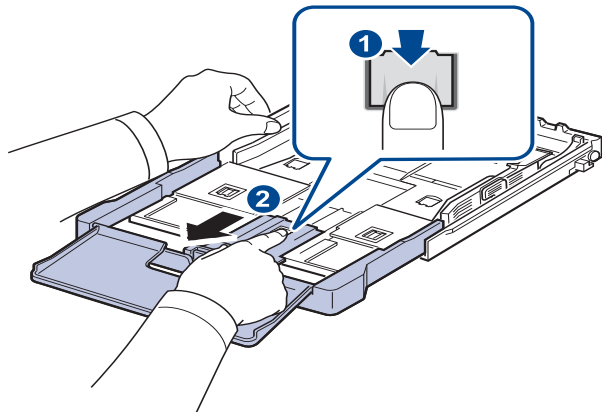

3. Load paper into the tray.

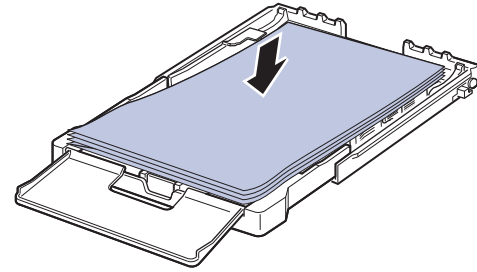

4. Slide the paper length guide until it lightly touches the end of the paper stack. Squeeze the paper width guide and slide it to the edge of the paper stack without causing it to bend.

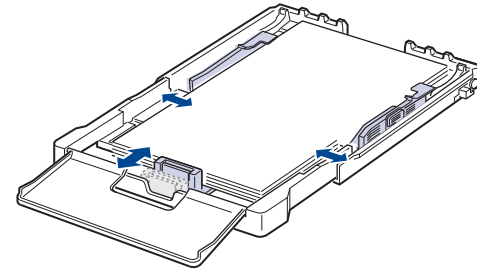

For paper smaller than Letter-sized, return the paper guides to their original positions and adjust the paper length guide and paper width guide.

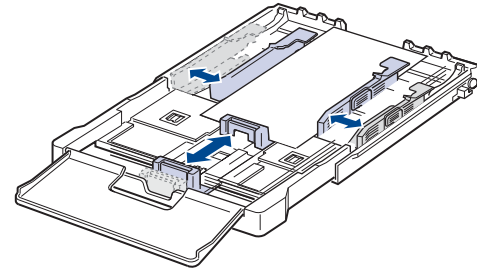

If the paper that you need to print is shorter than length 222 mm (8.74 inches), press and unlatch the guide lock in the tray, push the tray in

manually. Adjust the paper length guide and paper width guide.

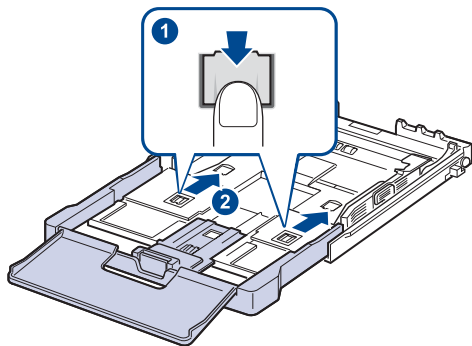

- Do not push the paper width guides far enough to cause the materials to warp.
- If you do not adjust the paper width guides, it may cause paper jams.

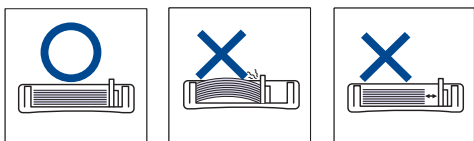

5. Close the paper cover.

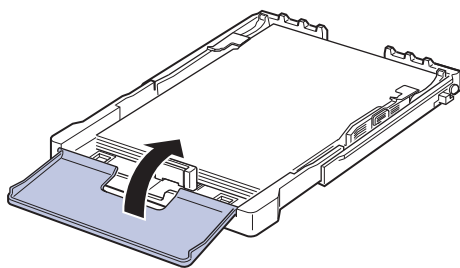

6. Slide the tray back into the machine until it clicks.
7. After loading paper, set the paper type and size for the tray. See "Setting the paper size and type" on page 30.

- If you experience problems with paper feed, place one sheet at a time in the tray.
- You can load previously printed paper. The printed side should be facing up with an uncurled edge at the rear. If you experience problems with paper feed, turn the paper around. Note that print quality is not guaranteed.

The tray is preset to Letter or A4 size, depending on your country. To change the size to A4 or Letter, you must adjust the lever and paper width guide properly.

- 1 Pull the tray out of the machine. Open the paper cover and remove paper from the tray if necessary.
- 2 If you want to change the size to Letter, hold the lever at the back of the tray, and rotate the lever clockwise.

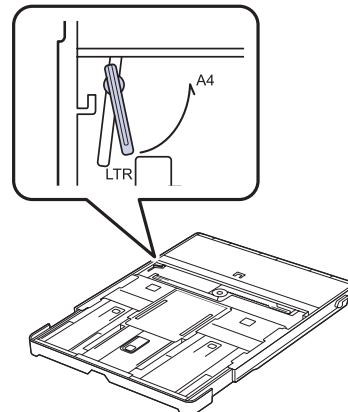

3 Squeeze the paper width guide and slide it to the edge of the lever.

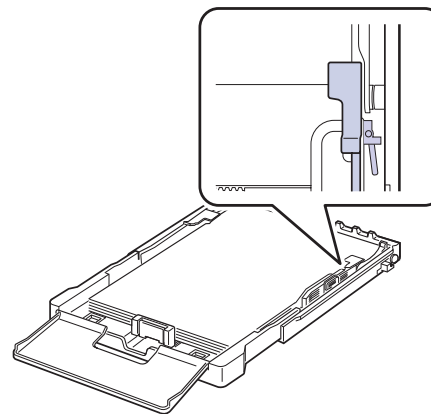

- If you want to change the size to A4, first move the paper width guide to left and rotate the lever counterclockwise. If you force the lever, it could damage the tray.

PRINTING ON SPECIAL PRINT MATERIALS

The machine can hold special sizes and types of print material, such as postcards, note cards, and envelopes. Especially, it is useful for single page printing on letterhead or colored paper.

Feeding the print material manually

- Load only one size of print media at a time in the tray.
- To prevent paper jams, do not add paper when there is still paper in the tray. This also applies to other types of print media.
- Print media should be loaded face up with the side you want to print, and the top edge going into the tray first. Place print materials in the center of the tray.
- Always load only the specified print media to avoid paper jams and print quality problems. (See "Selecting print media" on page 25.)
- Flatten any curl on postcards, envelopes, and labels before loading them into the tray.

1. Load the paper. (See "Changing the size of the paper in the paper tray" on page 28.)



Depending on the media type you are using, keep the following loading guidelines:

- Envelopes: Flap side down and with the stamp area on the top left side.
- Labels: Print side up and top short edge entering the machine first.
- Preprinted paper: Design side up with the top edge toward the machine.
- Card stock: Print side up and the short edge entering the machine first.
- Previously printed paper: Previously printed side down with an uncurled edge toward the machine.

2. When you print in application, start the print menu.
3. Before you print, open printer properties.
4. Press the **Paper** tab in printer properties, and select an appropriate paper type.



If you want to use an label, set the paper type to **Label**.

5. Select **Manual Feeder** in paper source then, press **OK**.
6. Start printing in application.
7. Press the  **Stop** button on the machine to start feeding then the machine starts printing.



- If you are printing multiple pages, load the next sheet after first page prints out, and press the  **Stop** button. Repeat this step for every page to be printed.
- The settings you change remain in effect only while you are using the current application.

ADJUSTING THE OUTPUT SUPPORT

The printed pages stack on the output tray, and the output support will help the printed pages align. To let the output support correctly align the pages you need to pull it out appropriately depending on the paper size.

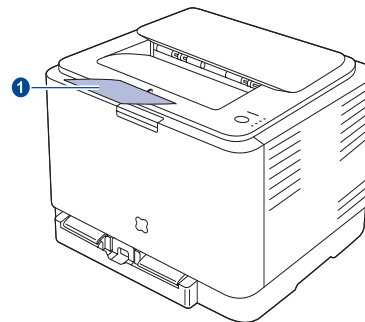

1 Output support



- If the output support is incorrectly adjusted, printed pages may be mis-aligned or fall.
- If you continuously print many pages, the surface of the output tray may become hot. Be careful not to touch the surface, and especially keep children away from the surface.

SETTING THE PAPER SIZE AND TYPE

After loading paper in the paper tray, you need to set the paper size and type using the printer driver. Follow these steps to make your changes permanent.



The following procedure is for Windows XP. For other Windows OS, refer to the corresponding Windows User's Guide or online help.

1. Click the **Start** button on the computer screen.
2. Select **Printers and Faxes**.
3. Right-click on the printer driver icon and select **Printing Preferences**.
4. Click the **Paper** tab, and change the settings on **Paper Options**.
5. Click **OK**.

basic printing

This chapter explains common printing tasks.

This chapter includes:

- Printing a document
- Canceling a print job

PRINTING A DOCUMENT

Your machine allows you to print from various Windows, Macintosh, or Linux applications. The exact steps for printing a document may vary depending on the application you use.

For details about printing, see the *Software section*.

CANCELING A PRINT JOB

If the print job is waiting in a print queue or print spooler, such as the printer group in Windows, delete the job as follows:

1. Click the Windows **Start** menu.
2. For Windows 2000, select **Settings** and then **Printers**.
For Windows XP/2003, select **Printers and Faxes**.
For Windows Vista, select **Control Panel > Hardware and Sound > Printers**.
3. Double-click the Samsung CLP-310 Series icon.
4. From the **Document** menu, select **Cancel**.



You can also access this window by simply double-clicking the printer icon at the bottom right corner of the Windows desktop.

You can also cancel the current job by pressing  **Stop** on the control panel.

maintenance

This chapter provides information for maintaining your machine and the toner cartridge.

This chapter includes:

- Printing reports
- Cleaning your machine
- Maintaining the cartridge
- Replacing the toner cartridge

PRINTING REPORTS

You can print a configuration report from the machine's control panel. Use the configuration page to view the current settings, to help troubleshoot problems. In Ready mode, press and hold the  **Stop** button on the control panel for about 5 seconds.

CLEANING YOUR MACHINE

To maintain print quality, follow the cleaning procedures below each time the toner cartridge is replaced or if print quality problems occur.

- ⚠ • Cleaning the cabinet of the machine with cleaning materials containing large amounts of alcohol, solvent, or other strong substances can discolor or distort the cabinet.
- If your machine or its surrounding is contaminated with toner, we recommend you to use cloth or tissue dampened with water to clean it. If you use a vacuum cleaner, toner blown into the air may be harmful.

Cleaning the outside

Clean the cabinet of the machine with a soft lint-free cloth. You can dampen the cloth slightly with water, but be careful not to let any water drip onto or into the machine.

Cleaning the inside

During the printing process, paper, toner, and dust particles can accumulate inside the machine. This buildup can cause print quality problems, such as toner specks or smearing. Cleaning the inside of the machine clears or reduces these problems.

1. Turn the machine off and unplug the power cord. Wait for the machine to cool down.
2. Press the release button, completely open the front cover.

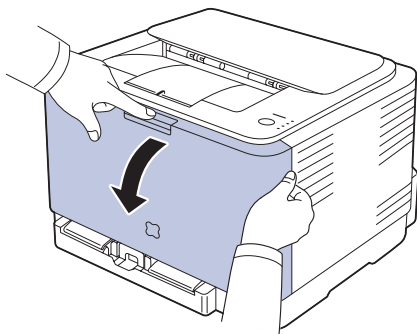

- Replacing the Imaging Unit
- Replacing the waste toner container
- Maintenance parts
- Managing your machine from the website

3. Grasp the handles on the toner cartridge and pull to remove the cartridge from the machine.

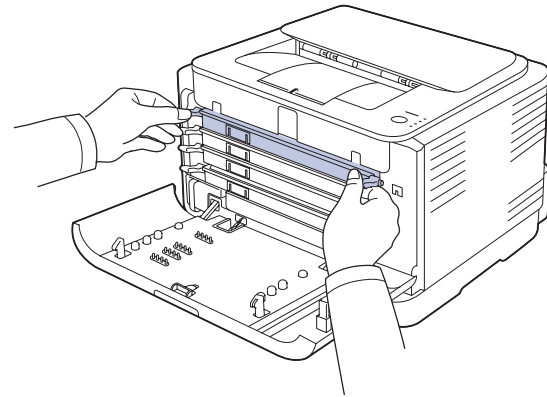

4. Pull the waste toner container out of the machine using its handle.

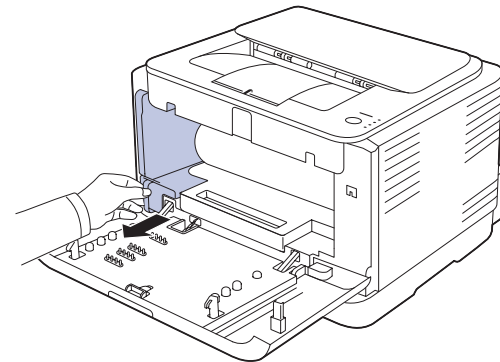

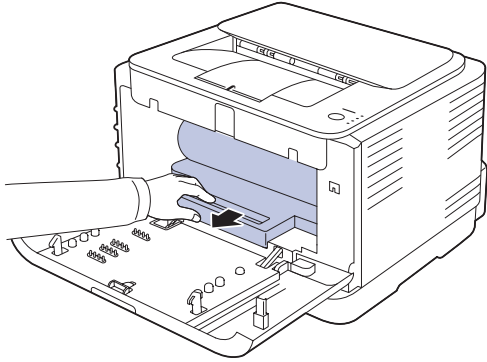

5. Pull the imaging unit out of the machine using the groove on the front of the imaging unit.

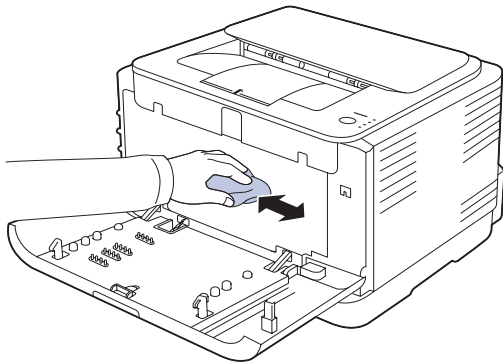

-  • Do not touch the green surface on the imaging unit with your hands or any other material.
- Be careful not to scratch the surface of the imaging unit.
 - If you leave the front cover open for more than a few minutes, the imaging unit can be exposed to light. This will cause damage to the imaging unit. Close the front cover should the installation need to be halted for any reason.
6. With a dry lint-free cloth, wipe away any dust and spilled toner from the toner cartridges area and their cavities.



-  • If toner gets on your clothing, wipe it off with a dry cloth and wash it in cold water. Hot water sets toner into fabric.
- If your machine or its surrounding is contaminated with toner, we recommend you to use a cloth or tissue dampened with water to clean it. If you use a vacuum cleaner, toner blows into the air then might be harmful to you.
-  After cleaning, let the machine to dry completely.

7. Holding the groove on the front of the imaging unit, push imaging unit in to the machine.

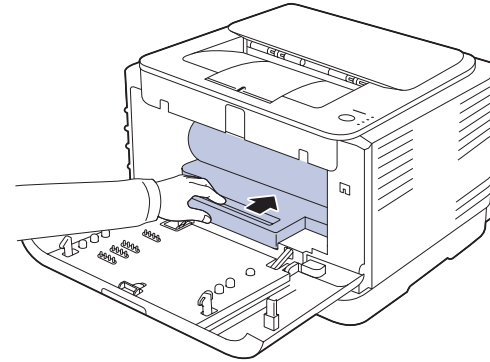

8. Insert the waste toner container into position and then push it to make sure that it is firmly seated in place.

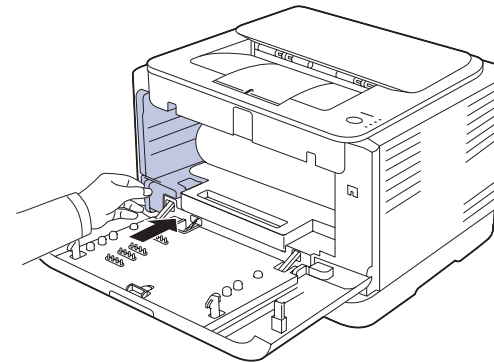

9. Slide the toner cartridge back into the machine.

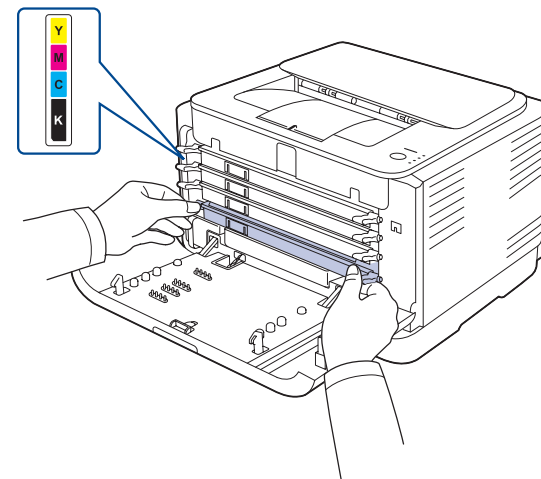

10. Reinstall all the compartments into the machine, and close the front cover.

-  If the front cover is not completely closed, the machine will not operate.

11. Plug in the power cord and turn the machine on

MAINTAINING THE CARTRIDGE

Toner cartridge storage

To get the most from the toner cartridge, keep the following guidelines in mind:

- Do not remove the toner cartridge from its package until ready for use.
- Do not refill the toner cartridge. The machine warranty does not cover damage caused by using a refilled cartridge.
- Store toner cartridges in the same environment as your machine.
- To prevent damage to the toner cartridge, do not expose it to light for more than a few minutes.

Expected cartridge life

The life of the toner cartridge yield depends on the amount of toner that print jobs require. The actual number may also be different depending on the print density of the pages you print on, and the number of pages may be affected by operating environment, printing interval, media type, and media size. If you print a lot of graphics, you may need to change the cartridge more often.

Redistributing toner

When a toner is low, faded or light areas may appear. It is possible that colored images may be printed with incorrect colors due to flawed mixing of toner colors when one of the colored toner cartridges is low on toner. You can temporarily improve print quality by redistributing the toner.

- The toner-related message saying that the toner is low may appear on the display.
- The SmartPanel program window appears on the computer telling you which color cartridge is low on toner.

1. Press the release button, completely open the front cover.

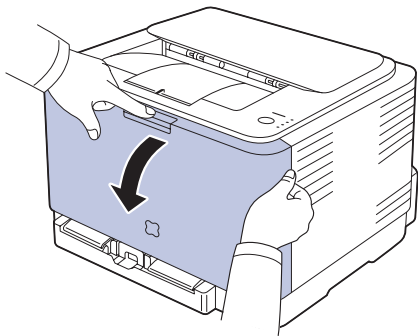

2. Grasp the handles on the toner cartridge and pull to remove the cartridge from the machine.

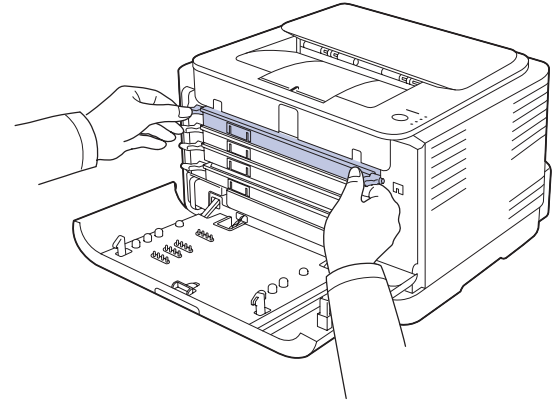

3. Holding both handles on the toner cartridge, thoroughly rock it from side to side to evenly distribute the toner.

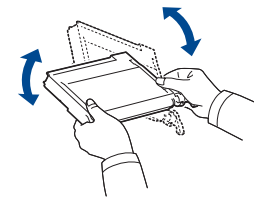

If toner gets on your clothing, wipe it off with a dry cloth and wash it in cold water. Hot water sets toner into fabric.

4. Slide the toner cartridge back into the machine.

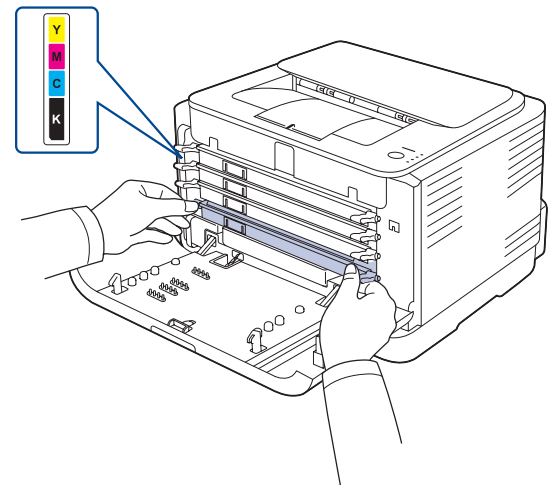

5. Close the front cover. Make sure the cover is securely latched.



If the front cover is not completely closed, the machine will not operate.

REPLACING THE TONER CARTRIDGE

The machine uses four colors and has a different toner cartridge for each one: yellow (Y), magenta (M), cyan (C), and black (K).

When the toner colors LED, on the control panel, indicating each individual toner cartridge according to its color, lights, and the status LED lights red, the machine cartridge is totally exhausted. Your machine stops printing. Also, the Smart Panel program window appears on the computer telling you to replace the cartridge.

At this stage, the toner cartridge needs to be replaced. Check the type of toner cartridge for your machine. (See "Supplies" on page 47.)

1. Turn the machine off, then wait a few minutes for the machine to cool.
2. Press the release button, completely open the front cover.

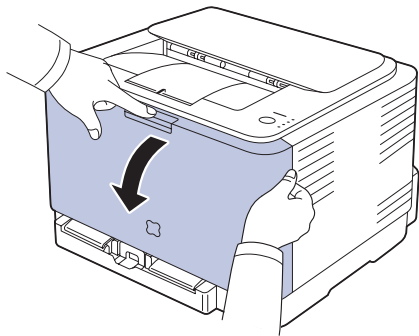

3. Grasp the handles on the toner cartridge and pull to remove the cartridge from the machine.

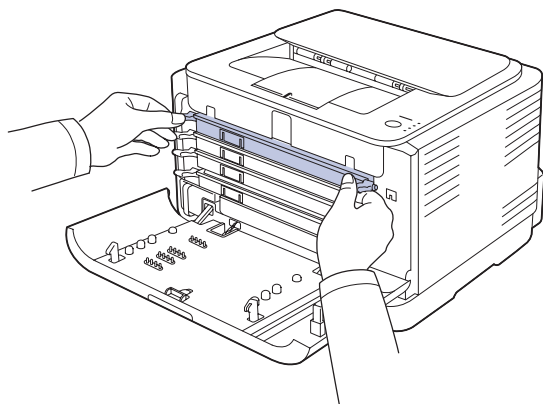

4. Take a new toner cartridge out of its package.



- Don't use sharp objects, such as a knife or scissors, to open the toner cartridge package. You could damage the surface of the toner cartridge.
- To prevent damage, do not expose the toner cartridge to light for more than a few minutes. Cover it with a piece of paper to protect it if necessary.

5. Holding both handles on the toner cartridge, thoroughly rock it from side to side to evenly distribute the toner.

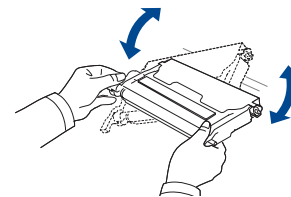

6. Place the toner cartridge on a flat surface, as shown, and remove the protecting cover.

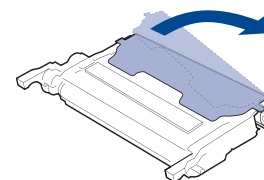

If toner gets on your clothing, wipe it off with a dry cloth and wash it in cold water. Hot water sets toner into fabric.

7. Make sure that the color of the toner cartridge matches the color slot and then grasp the handles on the toner cartridge. Insert the cartridge until it clicks into place.

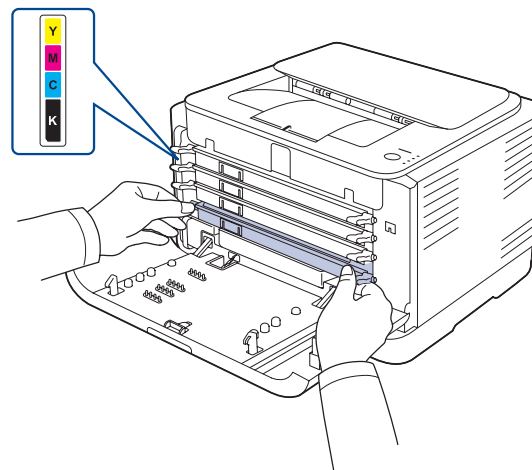

8. Close the front cover. Make sure the cover is securely latched, and then turn the machine on.



If the front cover is not completely closed, the machine will not operate.

REPLACING THE IMAGING UNIT

When the life span of the imaging unit has expired, the Smart Panel program window appears on the computer, indicating the imaging unit needs to be replaced. Otherwise your machine stops printing.

1. Turn the machine off, then wait a few minutes for the machine to cool.
2. Press the release button, completely open the front cover.

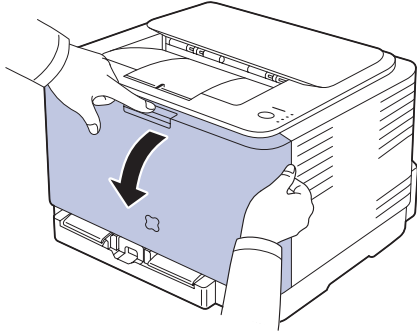

3. Grasp the handles on the toner cartridge and pull to remove the cartridge from the machine.

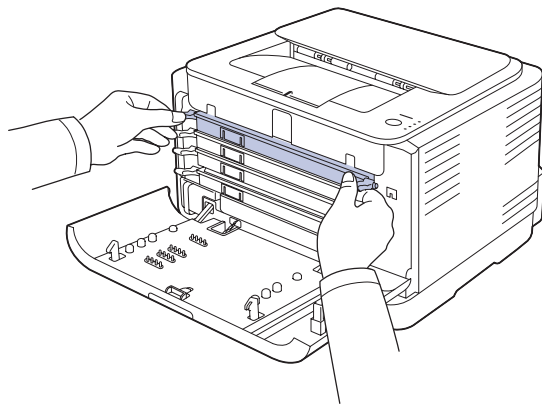

4. Pull the waste toner container out of the machine using its handle.

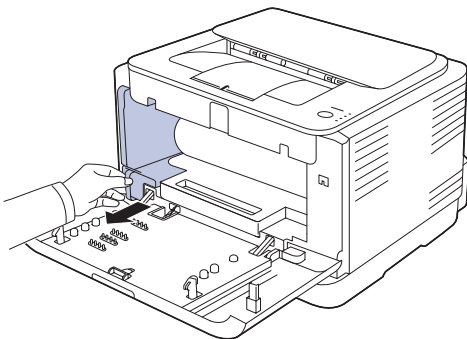

5. Pull the imaging unit out of the machine using the groove on the front of the imaging unit.

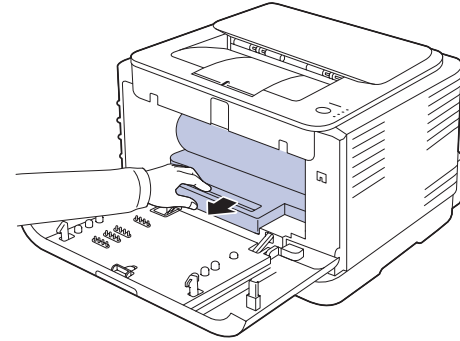

6. Take a new imaging unit out of its package.

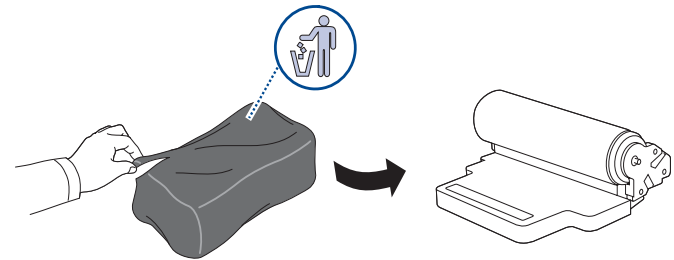

- Don't use sharp objects, such as a knife or scissors, to open the imaging unit package. You could damage the surface of the imaging unit.
- Be careful not to scratch the surface of the imaging unit.
- To prevent damage, do not expose the imaging unit to light for more than a few minutes. Cover it with a piece of paper to protect it if necessary.

7. Holding the groove on the front of the imaging unit, push imaging unit in to the machine.

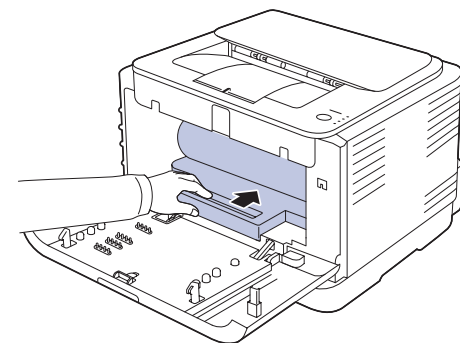

8. Insert the waste toner container into position and then push it to make sure that it is firmly seated in place.

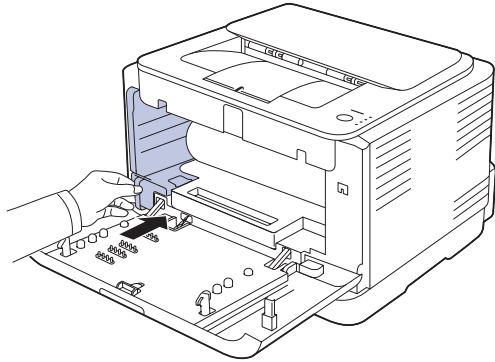

9. Slide the toner cartridge back into the machine.

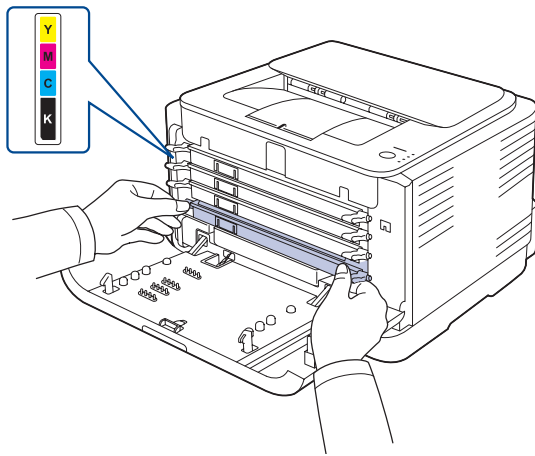

10. Close the front cover firmly.

 If the front cover is not completely closed, the machine will not operate. Please make sure all toner cartridges are installed properly. If any toner cartridge is installed improperly, the front cover do not close.

11. Turn the machine on.

 Each LED blinks red in a repeated order. Wait for about 1.5 minutes for your machine to get ready.

REPLACING THE WASTE TONER CONTAINER

When the life span of the waste toner container has expired, the Smart Panel program window appears on the computer, indicating the waste toner container needs to be replaced. Otherwise your machine stops printing.

1. Turn the machine off, then wait a few minutes for the machine to cool.
2. Open the front cover.

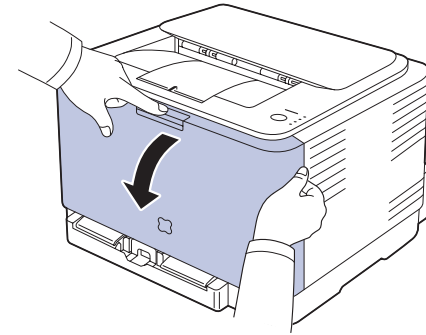

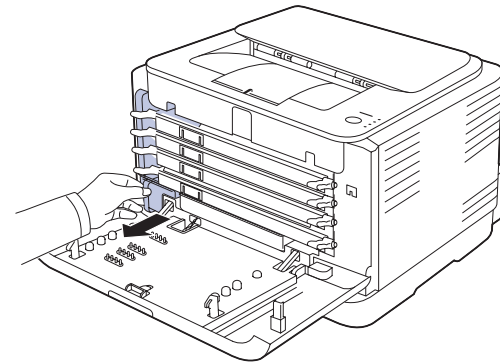

3. Pull the waste toner container out of the machine using its handle.

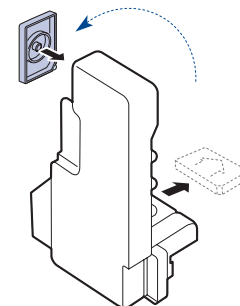

 Make sure that you lay the waste toner container on a flat surface so that the toner does not spill.

4. Remove the container's cap from the container as shown below, and use it to close the waste toner container opening.



 Do not tilt or turn over the container.

5. Take a new waste toner container out of its package.

6. Insert the new container into position and then push it to make sure that it is firmly seated in place.

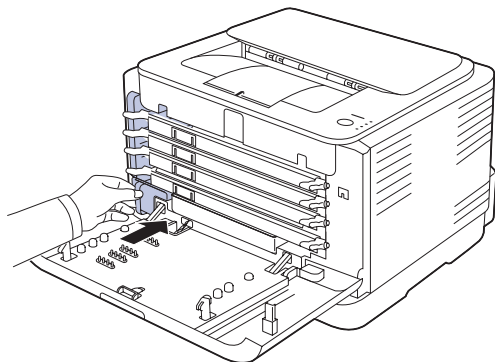

7. Close the front cover firmly.

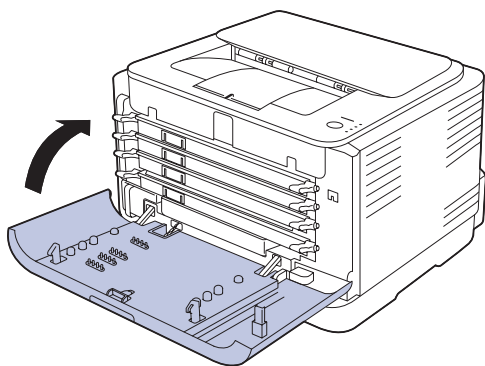

-  If the front cover is not completely closed, the machine will not operate. Please make sure all toner cartridges are installed properly. If any toner cartridge is installed improperly, the front cover do not close.

8. Turn the machine on.

MAINTENANCE PARTS

To avoid print quality and paper feed problems resulting from worn parts, and to maintain your machine in top working condition the following condition, the following items will need to be replaced after the specified number of pages, or when the life span of each item has expired.

ITEMS	YIELD (AVERAGE)
Pick-up roller	Approx. 50,000 pages
Fuser unit	Approx. 100,000 black pages or 25,000 color pages
Transfer roller	Approx. 100,000 pages
Transfer Unit (ITB)	Approx. 100,000 black pages or 25,000 color pages

We highly recommend that this maintenance be performed by an authorized service provider, dealer or the retailer where you bought the machine. The warranty does not cover the replacement of the maintenance parts after their lifespan.

MANAGING YOUR MACHINE FROM THE WEBSITE

If you have connected your machine to a network and set up TCP/IP network parameters correctly, you can manage the machine via Samsung's **SyncThru™ Web Service**, an embedded web server. Use **SyncThru™ Web Service** to:

- View the machine's device information and check its current status.
- Change TCP/IP parameters and set up other network parameters.
- Change the printer properties.
- Set the machine to send email notifications to let you know the machine's status.
- Get support for using the machine.

To access SyncThru™ Web Service:

1. Start a web browser, such as Internet Explorer, from Windows.
2. Enter the machine IP address (<http://xxx.xxx.xxx.xxx>) in the address field and press the **Enter** key or click **Go**.
Your machine's embedded website opens.

troubleshooting

This chapter gives helpful information for what to do if you encounter an error.

This chapter includes:

- Tips for avoiding paper jams
- Clearing paper jams

TIPS FOR AVOIDING PAPER JAMS

By selecting the correct media types, most paper jams can be avoided. When a paper jam occurs, follow the steps outlined on page 39.

- Follow the procedures on page 28. Ensure that the adjustable guides are positioned correctly.
- Do not overload the tray. Ensure that the paper level is below the paper capacity mark on the inside of the tray.
- Do not remove paper from the tray while your machine is printing.
- Flex, fan, and straighten paper before loading.
- Do not use creased, damp, or highly curled paper.
- Do not mix paper types in a tray.
- Use only recommended print media. (See "Setting the paper size and type" on page 30.)
- Ensure that the recommended side of the print media is facing up in the tray.

CLEARING PAPER JAMS

 To avoid tearing the paper, pull the jammed paper out gently and slowly. Follow the instructions in the following sections to clear the jam.

If a paper jam occurs, the status LED on the control panel lights red. Find and remove the jammed paper.

To resume printing after clearing paper jams, you must open and close the front cover or rear cover.

If paper is jammed in the paper feed area, follow the next steps to release the jammed paper.

1. Pull the tray out of the printer and remove the jammed paper.

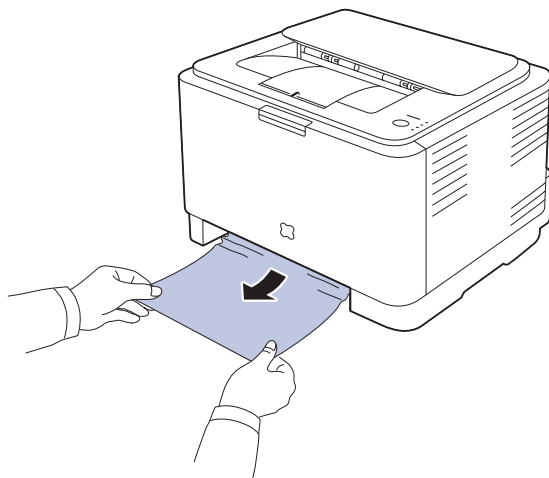

If you cannot find the jammed paper, go to the next step.

- Solving other problems

2. To remove the jammed paper, open the rear cover.

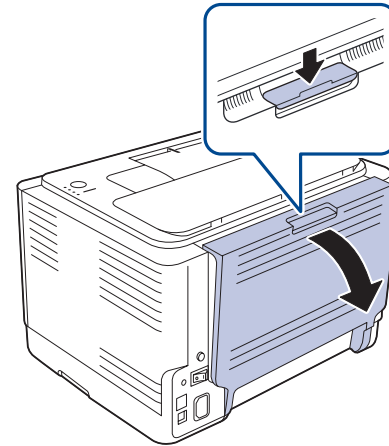

3. Carefully remove the paper by pulling in the direction as shown below. Most of the jammed paper can be removed in this step.

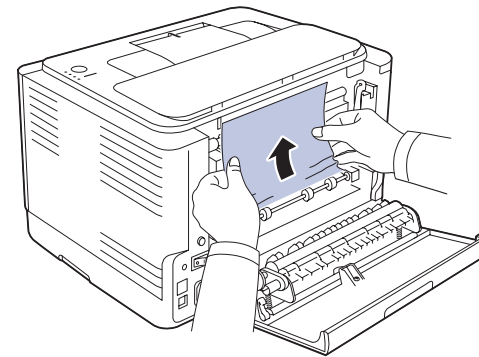

If you cannot find the jammed paper, or if there is any resistance removing the paper, stop pulling and go to the next step.

-  If the paper tears, make sure that all of the paper fragments are removed from the printer.

4. Push the fuser levers upwards.

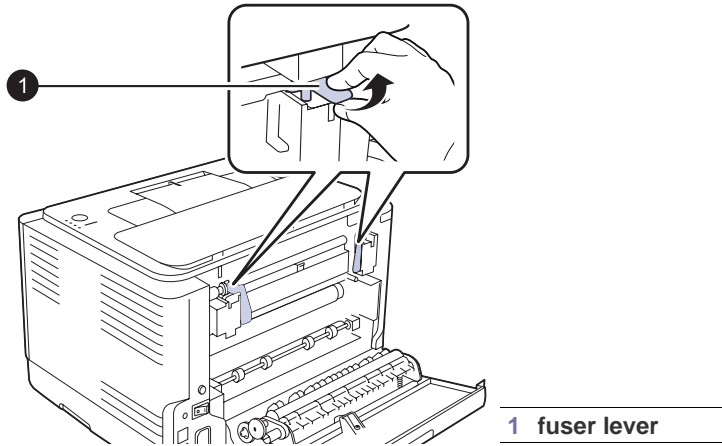

5. Open the top cover and inner cover.

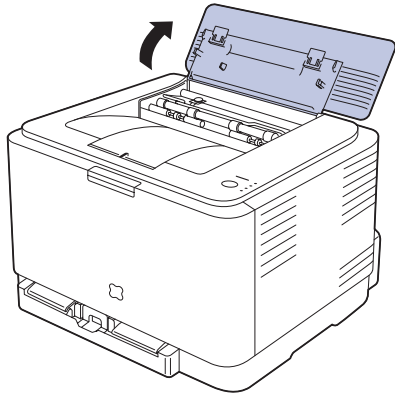

6. Holding the inner cover open, carefully take the jammed paper out of the printer. The inner cover will then close automatically.

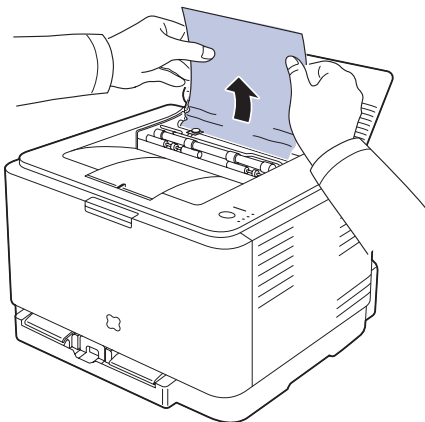

 Do not touch the fuser inside the inner cover. It is hot and could cause burns! The fuser's operating temperature is 180 °C (356 °F). Take care when removing paper from the printer.

7. Close the top cover. Make sure that it is securely closed.

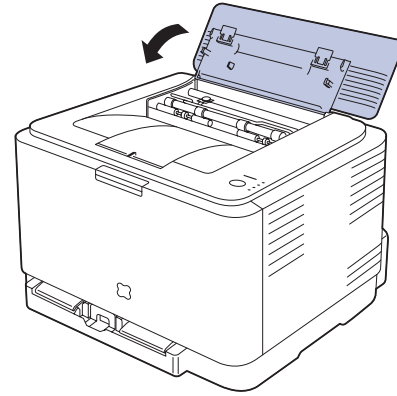

8. Push the fuser levers downwards.

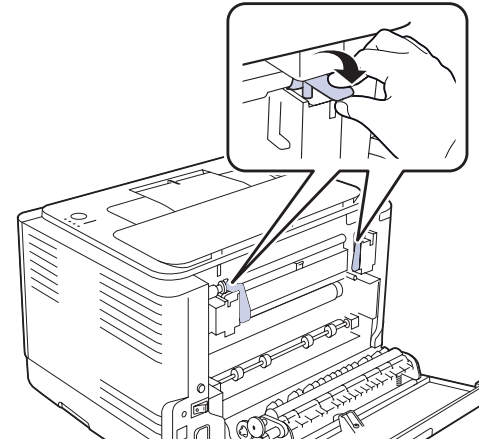

9. Open and then close the rear cover or front cover to resume printing.

SOLVING OTHER PROBLEMS

The following chart lists some conditions that may occur and the recommended solutions. Follow the suggested solutions until the problem is corrected. If the problem persists, call for service.

Paper feeding

CONDITION	SUGGESTED SOLUTIONS
Paper is jammed during printing.	Clear the paper jam. See page 39.
Paper sticks together.	<ul style="list-style-type: none"> Ensure there is not too much paper in the tray. The tray can hold up to 150 sheets of paper, depending on the thickness of your paper. Make sure that you are using the correct type of paper. See page 30. Remove paper from the tray and flex or fan the paper. Humid conditions may cause some paper to stick together.
Multiple sheets of paper do not feed.	<ul style="list-style-type: none"> Different types of paper may be stacked in the tray. Load paper of only one type, size, and weight. If multiple sheets have caused a paper jam, clear the paper jam. See page 39.
Paper does not feed into the machine.	<ul style="list-style-type: none"> Remove any obstructions from inside the machine. Paper has not been loaded correctly. Remove paper from the tray and reload it correctly. There is too much paper in the tray. Remove excess paper from the tray. The paper is too thick. Use only paper that meets the specifications required by the machine. See page 25.
The paper keeps jamming.	<ul style="list-style-type: none"> There is too much paper in the tray. Remove excess paper from the tray. If you are printing on special materials, load only one size of print media at a time in the tray. An incorrect type of paper is being used. Use only paper that meets the specifications required by the machine. See page 26. There may be debris inside the machine. Open the front cover and remove the debris.
Envelopes skew or fail to feed correctly.	Ensure the paper guides are against both sides of the envelopes.

Printing problems

CONDITION	POSSIBLE CAUSE	SUGGESTED SOLUTIONS
The machine does not print.	The machine is not receiving power.	Check the power cord connections. Check the power switch and the power source.
	The machine is not selected as the default printer.	Select Samsung CLP-310 Series as your default printer in your Windows.
		<ul style="list-style-type: none"> Check the machine for the following: <ul style="list-style-type: none"> The front cover is not closed. Close the cover. Paper is jammed. Clear the paper jam. See page 39. No paper is loaded. Load paper. See page 28. The toner cartridge is not installed. Install the toner cartridge. If a system error occurs, contact your service representative.
	The connection cable between the computer and the machine is not connected properly.	Disconnect the printer cable and reconnect it.
	The connection cable between the computer and the machine is defective.	If possible, attach the cable to another computer that is working properly and print a job. You can also try using a different printer cable.
	The port setting is incorrect.	Check the Windows printer setting to make sure that the print job is sent to the correct port. If the computer has more than one port, make sure that the machine is attached to the correct one.
	The machine may be configured incorrectly.	Check the printer properties to ensure that all of the print settings are correct.
	The printer driver may be incorrectly installed.	Repair the printer software. See the <i>Software section</i> .
	The machine is malfunctioning.	Check the LEDs status on the control panel to see if the machine is indicating a system error.
	The machine does not print special sized paper such as a billing paper.	Paper size and paper size setting do not match.

CONDITION	POSSIBLE CAUSE	SUGGESTED SOLUTIONS
The machine selects print materials from the wrong paper source.	The paper source selection in the printer properties may be incorrect.	For many software applications, the paper source selection is found under the Thin Paper tab within the printer properties. Select the correct paper source. See the printer driver help screen.
A print job is extremely slow.	The job may be very complex.	Reduce the complexity of the page or try adjusting the print quality settings.
Half the page is blank.	The page orientation setting may be incorrect.	Change the page orientation in your application. See the printer driver help screen.
	The paper size and the paper size settings do not match.	Ensure that the paper size in the printer driver settings matches the paper in the tray. Or, ensure that the paper size in the printer driver settings matches the paper selection in the software application settings you use.
The machine prints, but the text is wrong, garbled, or incomplete.	The printer cable is loose or defective.	Disconnect the printer cable and reconnect. Try a print job that you have already printed successfully. If possible, attach the cable and the machine to another computer and try a print job that you know works. Finally, try a new printer cable.
	The wrong printer driver was selected.	Check the application's printer selection menu to ensure that your machine is selected.
	The software application is malfunctioning.	Try printing a job from another application.
	The operating system is malfunctioning.	Exit Windows and reboot the computer. Turn the machine off and then back on again.
Pages print, but are blank.	The toner cartridge is defective or out of toner.	Redistribute the toner, if necessary. See page 34. If necessary, replace the toner cartridge.
	The file may have blank pages.	Check the file to ensure that it does not contain blank pages.
	Some parts, such as the controller or the board, may be defective.	Contact a service representative.

CONDITION	POSSIBLE CAUSE	SUGGESTED SOLUTIONS
The printer does not print PDF file correctly. Some parts of graphics, text, or illustrations are missing.	Incompatibility between the PDF file and the Acrobat products.	Printing the PDF file as an image may solve this problem. Turn on Print As Image from the Acrobat printing options.  It will take longer to print when you print a PDF file as an image.
Your machine has an odd smell during initial use.	The oil used to protect the fuser is evaporating.	After printing about 100 color pages, there will be no more smell. It is a temporary issue.
The print quality of photos is not good. Images are not clear.	The resolution of the photo is very low.	Reduce the photo size. If you increase the photo size in the software application, the resolution will be reduced.
Before printing, the machine emits vapor near the output tray.	Using damp paper can cause vapor during printing.	This is not a problem. Just keep printing.

Printing quality problems

If the inside of the machine is dirty or paper has been loaded improperly, you may notice a reduction in print quality. See the table below to clear the problem.

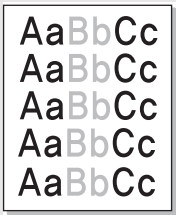
CONDITION	SUGGESTED SOLUTIONS
Light or faded print 	<p>If a vertical white streak or faded area appears on the page:</p> <ul style="list-style-type: none"> The toner supply is low. You may be able to temporarily extend the toner cartridge life. See page 35. If this does not improve the print quality, install a new toner cartridge. The paper may not meet paper specifications; for example, the paper is too moist or too rough. See page 25. If the entire page is light, the print resolution setting is too low. Adjust the print resolution. See the help screen of the printer driver. A combination of faded or smeared defects may indicate that the toner cartridge needs cleaning. The surface of the LSU part inside the machine may be dirty. Clean the LSU by opening and closing the front cover several times and if the problem still occurs call the contact a service representative.

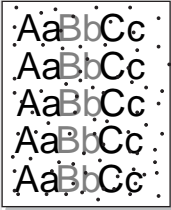
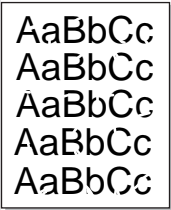
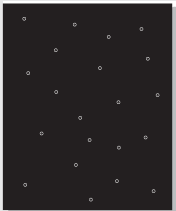
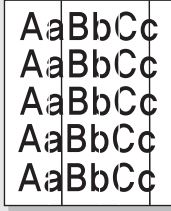
CONDITION	SUGGESTED SOLUTIONS
Toner specks 	<ul style="list-style-type: none"> The paper may not meet specifications; for example, the paper is too moist or too rough. See page 25. The paper path may need cleaning. See "Cleaning the inside" on page 32.
Dropouts 	<p>If faded areas, generally rounded, occur randomly on the page:</p> <ul style="list-style-type: none"> A single sheet of paper may be defective. Try reprinting the job. The moisture content of the paper is uneven or the paper has moist spots on its surface. Try a different brand of paper. See page 25. The paper lot is bad. The manufacturing processes can cause some areas to reject toner. Try a different kind or brand of paper. Change the printer option and try again. Go to printer properties, click Paper tab, and set type to Thick Paper. Refer to the <i>Software section</i> for details. <p>If these steps do not correct the problem, contact a service representative.</p>
White Spots 	<p>White spots appear on the page:</p> <ul style="list-style-type: none"> The paper is too rough and a lot of dirt from the paper falls to the inner devices within the machine, which means the transfer belt may be dirty. Clean the inside of your machine. Contact a service representative. The paper path may need cleaning. Contact a service representative.
Vertical lines 	<p>If black vertical streaks appear on the page:</p> <ul style="list-style-type: none"> The imaging unit has probably been scratched. Remove the imaging unit and install a new one. See page 36. <p>If white vertical streaks appear on the page:</p> <ul style="list-style-type: none"> The surface of the LSU part inside the machine may be dirty. Clean the LSU by opening and closing the front cover several times and if the problem still occurs call the contact a service representative.

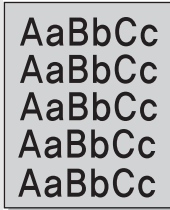
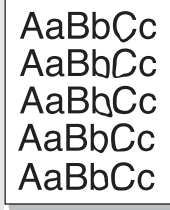
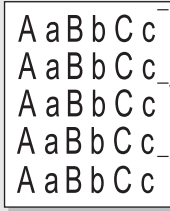
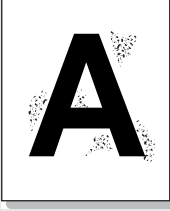
CONDITION	SUGGESTED SOLUTIONS
Color or Black background 	<p>If the amount of background shading becomes unacceptable:</p> <ul style="list-style-type: none"> Change to a lighter weight paper. See page 25. Check the machine's environment: very dry (low humidity) or high humidity (higher than 80% RH) conditions can increase the amount of background shading. Remove the old toner cartridge and install a new one. See page 35.
Toner smear 	<ul style="list-style-type: none"> Clean the inside of the machine. See page 32. Check the paper type and quality. See page 25. Remove the toner cartridge and install a new one. See page 35.
Vertical repetitive defects 	<p>If marks repeatedly appear on the printed side of the page at even intervals:</p> <ul style="list-style-type: none"> The toner cartridge may be damaged. If a repetitive mark occurs on the page, print a cleaning sheet several times to clean the cartridge. After the printout, if you still have the same problems, remove the toner cartridge and install a new one. See page 35. Parts of the machine may have toner on them. If the defects occur on the back of the page, the problem will likely correct itself after a few more pages. The fusing assembly may be damaged. Contact a service representative.
Background scatter 	<p>Background scatter results from bits of toner randomly distributed on the printed page.</p> <ul style="list-style-type: none"> The paper may be too damp. Try printing with a different batch of paper. Do not open packages of paper until necessary so that the paper does not absorb too much moisture. If background scatter occurs on an envelope, change the printing layout to avoid printing over areas that have overlapping seams on the reverse side. Printing on seams can cause problems. If background scatter covers the entire surface area of a printed page, adjust the print resolution through your software application or the printer properties.

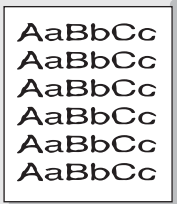
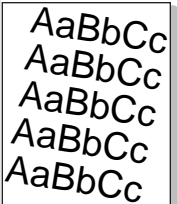
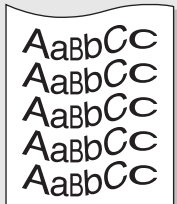
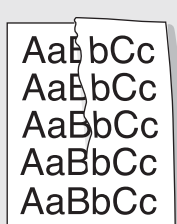
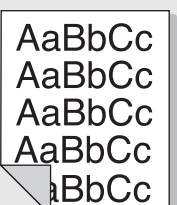
CONDITION	SUGGESTED SOLUTIONS
Misformed characters 	<ul style="list-style-type: none"> If characters are improperly formed and producing hollow images, the paper stock may be too slick. Try a different paper. See page 25.
Page skew 	<ul style="list-style-type: none"> Ensure that the paper is loaded properly. Check the paper type and quality. See page 25. Ensure that the paper or other material is loaded correctly and the guides are not too tight or too loose against the paper stack.
Curl or wave 	<ul style="list-style-type: none"> Ensure that the paper is loaded properly. Check the paper type and quality. Both high temperature and humidity can cause paper curl. See page 25. Turn over the stack of paper in the tray. Also try rotating the paper 180° in the tray.
Wrinkles or creases 	<ul style="list-style-type: none"> Ensure that the paper is loaded properly. Check the paper type and quality. See page 25. Turn over the stack of paper in the tray. Also try rotating the paper 180° in the tray.
Back of printouts are dirty 	<ul style="list-style-type: none"> Check for leaking toner. Clean the inside of the machine. See page 32.

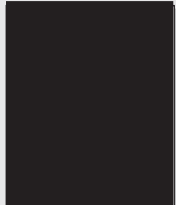
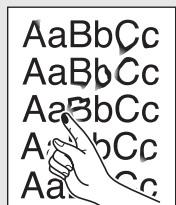
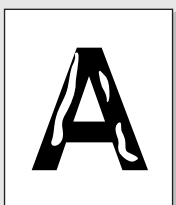
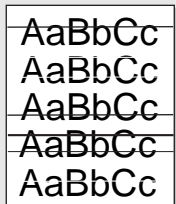
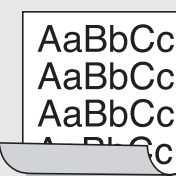
CONDITION	SUGGESTED SOLUTIONS
Solid Color or Black pages 	<ul style="list-style-type: none"> The toner cartridge may not be installed properly. Remove the cartridge and reinsert it. The toner cartridge may be defective and need replacing. Remove the toner cartridge and install a new one. See page 35. The machine may require repair. Contact a service representative.
Loose toner 	<ul style="list-style-type: none"> Clean the inside of the machine. See page 32. Check the paper type and quality. See page 25. Remove the toner cartridge and install a new one. See page 35. If the problem persists, the machine may require repair. Contact a service representative.
Character Voids 	<p>Character voids are white areas within parts of characters that should be solid black:</p> <ul style="list-style-type: none"> If you are using transparencies, try another type of transparency. Because of the composition of transparencies, some character voids are normal. You may be printing on the wrong surface of the paper. Remove the paper and turn it around. The paper may not meet paper specifications. See page 25.
Horizontal stripes 	<p>If horizontally aligned black streaks or smears appear:</p> <ul style="list-style-type: none"> The toner cartridge may be installed improperly. Remove the cartridge and reinsert it. The toner cartridge may be defective. Remove the toner cartridge and install a new one. See page 35. If the problem persists, the machine may require repair. Contact a service representative.
Curl 	<p>If the printed paper is curled or paper does not feed into the machine:</p> <ul style="list-style-type: none"> Turn over the stack of paper in the tray. Also try rotating the paper 180° in the tray. Change the printer option and try again. Go to printer properties, click Paper tab, and set type to Thin Paper. Refer to the <i>Software section</i> for details.
An unknown image repetitively appears on a next few sheets or loose toner, light print, or contamination occurs.	<p>Your printer is probably being used at an altitude of 1,000 m (3,281 ft) or above. The high altitude may affect the print quality such as loose toner or light imaging. You can set this option through Printer Settings Utility or Printer tab in printer driver's properties. See page 24.</p>

Common Windows problems

CONDITION	SUGGESTED SOLUTIONS
“File in Use” message appears during installation.	Exit all software applications. Remove all software from the StartUp Group, then restart Windows. Reinstall the printer driver.
“General Protection Fault”, “Exception OE”, “Spool32”, or “Illegal Operation” messages appear.	Close all other applications, reboot Windows and try printing again.
“Fail To Print”, “A printer timeout error occurred.” messages appear.	These messages may appear during printing. Just keep waiting until the machine finishes printing. If the message appears in ready mode or after printing has been completed, check the connection and/or whether an error has occurred.

 Refer to the Microsoft Windows documentation that came with your computer for further information on Windows error messages.

Common Linux problems

CONDITION	SUGGESTED SOLUTIONS
The machine does not print.	<ul style="list-style-type: none"> • Check if the printer driver is installed in your system. Open Unified Driver Configurator and switch to the Printers tab in Printers configuration window to look at the list of available printers. Make sure that your machine is displayed on the list. If not, please, invoke Add new printer wizard to set up your device. • Check if the printer is started. Open Printers configuration and select your machine on the printers list. Look at the description in the Selected printer pane. If its status contains “(stopped)” string, please, press the Start button. After that normal operation of the printer should be restored. The “stopped” status might be activated when some problems in printing occurred. • Check if your application has special print option such as “-oraw”. If “-oraw” is specified in the command line parameter then remove it to print properly. For Gimp front-end, select “print” -> “Setup printer” and edit command line parameter in the command item.
Some color images come out all black.	This is a known bug in Ghostscript (until GNU Ghostscript version 7.05) when the base color space of the document is indexed color space and it is converted through CIE color space. Because Postscript uses CIE color space for Color Matching System, you should upgrade Ghostscript on your system to at least GNU Ghostscript version 7.06 or later. You can find recent Ghostscript versions at www.ghostscript.com .

CONDITION	SUGGESTED SOLUTIONS
Some color images come out in unexpected color.	This is a known bug in Ghostscript (until GNU Ghostscript version 7.xx) when the base color space of the document is indexed RGB color space and it is converted through CIE color space. Because Postscript uses CIE color space for Color Matching System, you should upgrade Ghostscript on your system to at least GNU Ghostscript version 8.xx or later. You can find recent Ghostscript versions at www.ghostscript.com .
The machine does not print whole pages and its output is half page printed.	It is a known problem that occurs when a color printer is used on version 8.51 or earlier of Ghostscript, 64-bit Linux OS, and reported to bugs.ghostscript.com as Ghostscript Bug 688252. The problem is solved in AFPL Ghostscript v. 8.52 or above. Download the latest version of AFPL Ghostscript from http://sourceforge.net/projects/ghostscript/ and install it to solve this problem.
I encounter error “Unable to open mfp port device file!” when printing a document.	Please avoid changing print job parameters (via LPR GUI, for example) while a print job is in progress. Known versions of CUPS server break the print job whenever print options are changed and then try to restart the job from the beginning. Since Unified Linux Driver locks mfp port while printing, the abrupt termination of the driver keeps the port locked and therefore unavailable for subsequent print jobs. If this situation occurred, please, try to release the mfp port.
When printing a document over the network in SuSE 9.2, the printer does not print.	The CUPS (Common Unix Printing System) version distributed with SuSE Linux 9.2 (cups-1.1.21) has a problem with ipp (Internet Printing Protocol) printing. Use the socket printing instead of ipp or install later version of CUPS (cups-1.1.22 or higher).

 Refer to Linux User's Guide that came with your computer for further information on Linux error messages.

Common Macintosh problems

CONDITION	SUGGESTED SOLUTIONS
The printer does not print PDF file correctly. Some parts of graphics, text, or illustrations are missing.	<p>Incompatibility between the PDF file and the Acrobat products: Printing the PDF file as an image may solve this problem. Turn on Print As Image from the Acrobat printing options.</p> <p> It will take longer to print when you print a PDF file as an image.</p>
The document has printed, but the print job has not disappeared from the spooler in Mac OS 10.3.2.	<p>Update your Mac OS to OS 10.3.3. or higher.</p>
Some letters are not displayed normally during the Cover page printing.	<p>This problem is caused because Mac OS cannot create the font during the Cover page printing. English alphabet and numbers are displayed normally at the Cover page.</p>

 Refer to Mac OS User's Guide that came with your computer for further information on Mac OS error messages.

ordering supplies and accessories

This chapter provides information on purchasing cartridges and accessories available for your machine.

This chapter includes:

- Supplies

 The optional parts or features may differ by countries. Contact your sales representatives whether the part you want is available in your country.

SUPPLIES

When the toner runs out, you can order the following type of toner cartridge for your machine:

TYPE	AVERAGE YIELD	PART NUMBER
Standard yield^a toner cartridge	<ul style="list-style-type: none">• Average continuous black cartridge yield: 1,500 standard pages (Black)• Average continuous color cartridge yield: 1,000 standard pages (Yellow/Magenta/Cyan)	CLT-K409S (Black) CLT-C409S (Cyan) CLT-M409S (Magenta) CLT-Y409S (Yellow) Region A^b CLT-K4092S (Black) CLT-C4092S (Cyan) CLT-M4092S (Magenta) CLT-Y4092S (Yellow)
Standard yield Imaging Unit	Approx. 24,000 images ^c	CLT-R409
Waste toner container	Approx. 10,000 images ^c	CLT-W409

a. Declared yield value in accordance with ISO/IEC 19798.

b. **Region A:** Albania, Austria, Belgium, Bosnia, Bulgaria, Croatia, Cyprus, Czech Republic, Denmark, Finland, France, Germany, Greece, Hungary, Italy, Macedonia, Netherlands, Norway, Poland, Portugal, Romania, Serbia, Slovakia, Slovenia, Spain, Sweden, Switzerland, UK,

c. Image counts based on one color on each page. If you print documents in full color (Cyan, Magenta, Yellow, Black), the life of this item will be reduced by 25%.

 When you purchase a new toner cartridge or supplies, you must purchase them in the same country you have purchased your machine. Otherwise, the toner cartridge or supplies will be incompatible with your machine since the configuration of the toner cartridge or supplies vary depending on the countries.

- How to purchase

HOW TO PURCHASE

To order Samsung-authorized supplies or accessories, contact your local Samsung dealer or the retailer where you purchased your machine, or visit www.samsung.com/supplies and select your country/region to obtain information on calling for technical support.

specifications

This chapter guides you about this machine's specifications such as various features.

This chapter include:

- General specifications
- Printer specifications

GENERAL SPECIFICATIONS

 The symbol * optional feature depending on machines.

ITEM	DESCRIPTION	
Paper input capacity	Tray: 150 sheets for plain paper, 75 g/m ² (20 lb bond) For details about paper input capacity, see 26 page.	
Paper output capacity	Face down: 100 sheets 75 g/m ² (20 lb bond)	
Power rating	AC 110 - 127 V or AC 220 - 240 V See the Rating label on the machine for the correct voltage, frequency (hertz) and type of current for your machine.	
Power consumption	<ul style="list-style-type: none"> • Average operating mode: Less than 350 WH • Ready mode: Less than 80 WH • Power Save mode: Less than 10 WH • Power off mode: 0 WH 	
Noise Level^a	Ready mode: Background noise level	
	Printing mode	Black & White: Less than 47 dBA Color: Less than 45 dBA
Default time to power save mode from ready mode	15 Minutes	
Warm-up time	Less than 35 seconds (Coldboot)	
Operating environment	Temperature: 10 to 32 °C (50 to 90 °F) Humidity: 20 to 80% RH	
Toner cartridge life^b	Black	Average continuous black cartridge yield: 1,500 standard pages (Shipped with 1,000 pages Starter toner cartridge.)
	Color (Yellow/Magenta/Cyan)	Average continuous color cartridge yield: 1,000 standard pages (Shipped with 700 pages Starter toner cartridge.)
Imaging Unit life	Approx. 24,000 images ^c	
Waste toner container	Approx. 10,000 images	

ITEM	DESCRIPTION
Memory	<ul style="list-style-type: none"> • CLP-310, CLP-310N, CLP-315, CLP-315N: 32 MB (Non-extendable) • CLP-310W, CLP-315W: 64 MB (Non-extendable)
External dimension (W x D x H)	388 x 313 x 243 mm (15.3 x 12.3 x 9.6 inches)
Weight (Including consumables)	11 Kg (24.25 lbs)
Package weight	Paper: 1.2 Kg (2.65 lbs) Plastic: 0.32 Kg (0.71 lbs)
Duty cycle	Up to 20,000 images (Monthly)
Fusing temperature	180 °C (356 °F)

a. Sound Pressure Level, ISO 7779

b. Declared yield value in accordance with ISO/IEC 19798. The number of pages may be affected by operating environment, printing interval, media type, and media size.

c. Image counts based on one color on each page. If you print documents in full color (Black, Cyan, Magenta, Yellow), the life of this item will be reduced by 25%.

PRINTER SPECIFICATIONS

ITEM	DESCRIPTION	
Printing method	Color laser beam printing	
Printing speed^a	<ul style="list-style-type: none"> Black and white: Up to 16 ppm (A4), 17 ppm (Letter) Color: Up to 4 ppm (A4/Letter) 	
First print out time	Black & White	From ready: Less than 14 seconds
	Color	From ready: Less than 26 seconds
Print resolution	Max. 2,400 x 600 dpi effective output	
Printer language	SPL-C	
OS compatibility^b	<ul style="list-style-type: none"> Windows: 2000/XP/2003/Vista Linux: RedHat 8.0~9.0, Mandrake 9.2~10.1, SuSE 8.2~9.2, Fedra Core 1~4 Macintosh: Mac OS X 10.3~10.5, Universal Mac 	
Interface	<ul style="list-style-type: none"> High speed USB 2.0 CLP-310N, CLP-310W, CLP-315N, CLP-315W only: Ethernet 10/100 Base TX wired LAN (embedded type) CLP-310W, CLP-315W only: 802.11 b/g wireless LAN 	

a. It will be affected by operating system used, computing performance, application software, connecting method, media type, media size and job complexity.

b. Visit www.samsungprinter.com to download the latest software version.

glossary

 The following glossary helps you get familiar with the product by understanding the terminologies commonly used with printing as well as mentioned in this user's guide.

ADF

An Automatic Document Feeder (ADF) is a mechanism that will automatically feed an original sheet of paper so that the machine can scan some amount of the paper at once.

AppleTalk

AppleTalk is a proprietary suite of protocols developed by Apple, Inc for computer networking. It was included in the original Macintosh (1984) and is now deprecated by Apple in favor of TCP/IP networking.

BIT Depth

A computer graphics term describing the number of bits used to represent the color of a single pixel in a bitmapped image. Higher color depth gives a broader range of distinct colors. As the number of bits increases, the number of possible colors becomes impractically large for a color map. 1-bit color is commonly called as monochrome or black and white.

BMP

A bitmapped graphics format used internally by the Microsoft Windows graphics subsystem (GDI), and used commonly as a simple graphics file format on that platform.

BOOTP

Bootstrap Protocol. A network protocol used by a network client to obtain its IP address automatically. This is usually done in the bootstrap process of computers or operating systems running on them. The BOOTP servers assign the IP address from a pool of addresses to each client. BOOTP enables 'diskless workstation' computers to obtain an IP address prior to loading any advanced operating system.

CCD

Charge Coupled Device (CCD) is a hardware which enables the scan job. CCD Locking mechanism is also used to hold the CCD module to prevent any damage when you move the machine.

Collation

Collation is a process of printing a multiple-copy job in sets. When collation is selected, the device prints an entire set before printing additional copies.

Control Panel

A control panel is a flat, typically vertical, area where control or monitoring instruments are displayed. They are typically found in front of the machine.

Coverage

It is the printing term used for a toner usage measurement on printing. For example, 5% coverage means that an A4 sided paper has about 5% image or text on it. So, if the paper or original has complicated images or lots of text on it, the coverage will be higher and at the same time, a toner usage will be as much as the coverage.

CSV

Comma Separated Values (CSV). A type of file format, CSV is used to exchange data between disparate applications. The file format, as it is used in Microsoft Excel, has become a pseudo standard throughout the industry, even among non-Microsoft platforms.

DADF

A Duplex Automatic Document Feeder (DADF) is a mechanism that will automatically feed and flip over an original sheet of paper so that the machine can scan on both sides of the paper.

Default

The value or setting that is in effect when taking a printer out of its box state, reset, or initialized.

DHCP

A Dynamic Host Configuration Protocol (DHCP) is a client-server networking protocol. A DHCP server provides configuration parameters specific to the DHCP client host requesting, generally, information required by the client host to participate on an IP network. DHCP also provides a mechanism for allocation of IP addresses to client hosts.

DIMM

Dual Inline Memory Module (DIMM), a small circuit board that holds memory. DIMM stores all the data within the machine like printing data, received fax data.

DNS

The Domain Name Server (DNS) is a system that stores information associated with domain names in a distributed database on networks, such as the Internet.

Dot Matrix Printer

A dot matrix printer refers to a type of computer printer with a print head that runs back and forth on the page and prints by impact, striking an ink-soaked cloth ribbon against the paper, much like a typewriter.

DPI

Dots Per Inch (DPI) is a measurement of resolution that is used for scanning and printing. Generally, higher DPI results in a higher resolution, more visible detail in the image, and a larger file size.

DRPD

Distinctive Ring Pattern Detection. Distinctive Ring is a telephone company service which enables a user to use a single telephone line to answer several different telephone numbers.

Duplex

A mechanism that will automatically flip over a sheet of paper so that the machine can print (or scan) on both sides of the paper. A printer equipped with a Duplex can print double-sided of paper.

Duty Cycle

Duty cycle is the page quantity which does not affect printer performance for a month. Generally the printer has the lifespan limitation such as pages per year. The lifespan means the average capacity of print-outs, usually within the warranty period. For example, if the duty cycle is 48,000 pages per month assuming 20 working days, a printer limits 2,400 pages a day.

ECM

Error Correction Mode (ECM) is an optional transmission mode built into Class 1 fax machines or fax modems. It automatically detects and corrects errors in the fax transmission process that are sometimes caused by telephone line noise.

Emulation

Emulation is a technique of one machine obtaining the same results as another.

An emulator duplicates the functions of one system with a different system, so that the second system behaves like the first system. Emulation focuses on exact reproduction of external behavior, which is in contrast to simulation, which concerns an abstract model of the system being simulated, often considering its internal state.

Ethernet

Ethernet is a frame-based computer networking technology for local area networks (LANs). It defines wiring and signaling for the physical layer, and frame formats and protocols for the media access control (MAC)/data link layer of the OSI model. Ethernet is mostly standardized as IEEE 802.3. It has become the most widespread LAN technology in use during the 1990s to the present.

EtherTalk

A suite of protocols developed by Apple Computer for computer networking. It was included in the original Macintosh (1984) and is now deprecated by Apple in favor of TCP/IP networking.

FDI

Foreign Device Interface (FDI) is a card installed inside the machine to allow a third party device such as a coin operated device or a card reader. Those devices allow the pay-for-print service on your machine.

FTP

A File Transfer Protocol (FTP) is a commonly used protocol for exchanging files over any network that supports the TCP/IP protocol (such as the Internet or an intranet).

Fuser Unit

The part of a laser printer that melts the toner onto the print media. It consists of a hot roller and a back-up roller. After toner is transferred onto the paper, the fuser unit applies heat and pressure to ensure that the toner stays on the paper permanently, which is why paper is warm when it comes out of a laser printer.

Gateway

A connection between computer networks, or between a computer network and a telephone line. It is very popular, as it is a computer or a network that allows access to another computer or network.

Grayscale

A shades of gray that represent light and dark portions of an image when color images are converted to grayscale; colors are represented by various shades of gray.

Halftone

An image type that simulates grayscale by varying the number of dots. Highly colored areas consist of a large number of dots, while lighter areas consist of a smaller number of dots.

HDD

Hard Disk Drive (HDD), commonly referred to as a hard drive or hard disk, is a non-volatile storage device which stores digitally-encoded data on rapidly rotating platters with magnetic surfaces.

IEEE

The Institute of Electrical and Electronics Engineers (IEEE) is an international non-profit, professional organization for the advancement of technology related to electricity.

IEEE 1284

The 1284 parallel port standard was developed by the Institute of Electrical and Electronics Engineers (IEEE). The term "1284-B" refers to a specific connector type on the end of the parallel cable that attaches to the peripheral (for example, a printer).

Intranet

A private network that uses Internet Protocols, network connectivity, and possibly the public telecommunication system to securely share part of an organization's information or operations with its employees. Sometimes the term refers only to the most visible service, the internal website.

IP address

An Internet Protocol (IP) address is a unique number that devices use in order to identify and communicate with each other on a network utilizing the Internet Protocol standard.

IPM

The Images Per Minute (IPM) is a way of measuring the speed of a printer. An IPM rate indicates the number of single-sided sheets a printer can complete within one minute.

IPP

The Internet Printing Protocol (IPP) defines a standard protocol for printing as well as managing print jobs, media size, resolution, and so forth. IPP can be used locally or over the Internet to hundreds of printers, and also supports access control, authentication, and encryption, making it a much more capable and secure printing solution than older ones.

IPX/SPX

IPX/SPX stands for Internet Packet Exchange/Sequenced Packet Exchange. It is a networking protocol used by the Novell NetWare operating systems. IPX and SPX both provide connection services similar to TCP/IP, with the IPX protocol having similarities to IP, and SPX having similarities to TCP. IPX/SPX was primarily designed for local area networks (LANs), and is a very efficient protocol for this purpose (typically its performance exceeds that of TCP/IP on a LAN).

ISO

The International Organization for Standardization (ISO) is an international standard-setting body composed of representatives from national standards bodies. It produces world-wide industrial and commercial standards.

ITU-T

The International Telecommunication Union is an international organization established to standardize and regulate international radio and telecommunications. Its main tasks include standardization, allocation of the radio spectrum, and organizing interconnection arrangements between different countries to allow international phone calls. A -T out of ITU-T indicates telecommunication.

ITU-T No. 1 chart

Standardized test chart published by ITU-T for document facsimile transmissions.

JBIG

Joint Bi-level Image Experts Group (JBIG) is an image compression standard with no loss of accuracy or quality, which was designed for compression of binary images, particularly for faxes, but can also be used on other images.

JPEG

Joint Photographic Experts Group (JPEG) is a most commonly used standard method of lossy compression for photographic images. It is the format used for storing and transmitting photographs on the World Wide Web.

LDAP

The Lightweight Directory Access Protocol (LDAP) is a networking protocol for querying and modifying directory services running over TCP/IP.

LED

A Light-Emitting Diode (LED) is a semiconductor device that indicates the status of a machine.

MAC address

Media Access Control (MAC) address is a unique identifier associated with a network adapter. MAC address is a unique 48-bit identifier usually written as 12 hexadecimal characters grouped in pairs (e. g., 00-00-0c-34-11-4e). This address is usually hard-coded into a Network Interface Card (NIC) by its manufacturer, and used as an aid for routers trying to locate machines on large networks.

MFP

Multi Function Peripheral (MFP) is an office machine that includes the following functionality in one physical body, so as to have a printer, a copier, a fax, a scanner and etc.

MH

Modified Huffman (MH) is a compression method for decreasing the amount of data that needs to be transmitted between the fax machines to transfer the image recommended by ITU-T T.4. MH is a codebook-based run-length encoding scheme optimized to efficiently compress white space. As most faxes consist mostly of white space, this minimizes the transmission time of most faxes.

MMR

Modified Modified READ (MMR) is a compression method recommended by ITU-T T.6.

Modem

A device that modulates a carrier signal to encode digital information, and also demodulates such a carrier signal to decode transmitted information.

MR

Modified Read (MR) is a compression method recommended by ITU-T T.4. MR encodes the first scanned line using MH. The next line is compared to the first, the differences determined, and then the differences are encoded and transmitted.

NetWare

A network operating system developed by Novell, Inc. It initially used cooperative multitasking to run various services on a PC, and the network protocols were based on the archetypal Xerox XNS stack. Today NetWare supports TCP/IP as well as IPX/SPX.

OPC

Organic Photo Conductor (OPC) is a mechanism that makes a virtual image for print using a laser beam emitted from a laser printer, and it is usually green or gray colored and a cylinder shaped.

An exposing unit of a drum is slowly worn away by its usage of the printer, and it should be replaced appropriately since it gets scratches from grits of a paper.

Originals

The first example of something, such as a document, photograph or text, etc, which is copied, reproduced or translated to produce others, but which is not itself copied or derived from something else.

OSI

Open Systems Interconnection (OSI) is a model developed by the International Organization for Standardization (ISO) for communications. OSI offers a standard, modular approach to network design that divides the required set of complex functions into manageable, self-contained, functional layers. The layers are, from top to bottom, Application, Presentation, Session, Transport, Network, Data Link and Physical.

PABX

A private automatic branch exchange (PABX) is an automatic telephone switching system within a private enterprise.

PCL

Printer Command Language (PCL) is a Page Description Language (PDL) developed by HP as a printer protocol and has become an industry standard. Originally developed for early inkjet printers, PCL has been released in varying levels for thermal, matrix printer, and page printers.

PDF

Portable Document Format (PDF) is a proprietary file format developed by Adobe Systems for representing two dimensional documents in a device independent and resolution independent format.

PostScript

PostScript (PS) is a page description language and programming language used primarily in the electronic and desktop publishing areas. - that is run in an interpreter to generate an image.

Printer Driver

A program used to send commands and transfer data from the computer to the printer.

Print Media

The media like paper, envelopes, labels, and transparencies which can be used on a printer, a scanner, a fax or, a copier.

PPM

Pages Per Minute (PPM) is a method of measurement for determining how fast a printer works, meaning the number of pages a printer can produce in one minute.

PRN file

An interface for a device driver, this allows software to interact with the device driver using standard input/output system calls, which simplifies many tasks.

Protocol

A convention or standard that controls or enables the connection, communication, and data transfer between two computing endpoints.

PS

See PostScript.

PSTN

The Public-Switched Telephone Network (PSTN) is the network of the world's public circuit-switched telephone networks which, on industrial premises, is usually routed through the switchboard.

Resolution

The sharpness of an image, measured in Dots Per Inch (DPI). The higher the dpi, the greater the resolution.

SMB

Server Message Block (SMB) is a network protocol mainly applied to share files, printers, serial ports, and miscellaneous communications between nodes on a network. It also provides an authenticated Inter-process communication mechanism.

SMTP

Simple Mail Transfer Protocol (SMTP) is the standard for e-mail transmissions across the Internet. SMTP is a relatively simple, text-based protocol, where one or more recipients of a message are specified, and then the message text is transferred. It is a client-server protocol, where the client transmits an email message to the server.

Subnet Mask

The subnet mask is used in conjunction with the network address to determine which part of the address is the network address and which part is the host address.

TCP/IP

The Transmission Control Protocol (TCP) and the Internet Protocol (IP); the set of communications protocols that implement the protocol stack on which the Internet and most commercial networks run.

TCR

Transmission Confirmation Report (TCR) provides details of each transmission such as job status, transmission result and number of pages sent. This report can be set to print after each job or only after failed transmissions.

TIFF

Tagged Image File Format (TIFF) is a variable-resolution bitmapped image format. TIFF describes image data that typically come from scanners. TIFF images make use of tags, keywords defining the characteristics of the image that is included in the file. This flexible and platform-independent format can be used for pictures that have been made by various image processing applications.

Toner Cartridge

A kind of bottle within a machine like printer which contains toner. Toner is a powder used in laser printers and photocopiers, which forms the text and images on the printed paper. Toner can be melted by the heat of the fuser, causing it to bind to the fibers in the paper.

TWAIN

An industry standard for scanners and software. By using a TWAIN-compliant scanner with a TWAIN-compliant program, a scan can be initiated from within the program.; an image capture API for Microsoft Windows and Apple Macintosh operating systems.

UNC Path

Uniform Naming Convention (UNC) is a standard way to access network shares in Window NT and other Microsoft products. The format of a UNC path is: \\<servername>\<sharename>\<Additional directory>

URL

Uniform Resource Locator (URL) is the global address of documents and resources on the Internet. The first part of the address indicates what protocol to use, the second part specifies the IP address or the domain name where the resource is located.

USB

Universal Serial Bus (USB) is a standard that was developed by the USB Implementers Forum, Inc., to connect computers and peripherals. Unlike the parallel port, USB is designed to concurrently connect a single computer USB port to multiple peripherals.

Watermark

A watermark is a recognizable image or pattern in paper that appears lighter when viewed by transmitted light. Watermarks were first introduced in Bologna, Italy in 1282; they have been used by papermakers to identify their product, and also on postage stamps, currency, and other government documents to discourage counterfeiting.

WIA

Windows Imaging Architecture (WIA) is an imaging architecture that is originally introduced in Windows Me and Windows XP. A scan can be initiated from within these operating systems by using a WIA-compliant scanner.

index

A

adjustment
altitude 24

C

cleaning
inside 32
outside 32

control panel 17

D

demo page, print 20

driver
installation 23

J

jam
tips for avoiding paper jams 39

L

LED
Status 18

Linux problems 45

M

Maintenance
maintenance parts 38
toner cartridge 34

N

network
setting up 21

P

paper
changing the size 28
clearing jam 39
printing special materials 30

paper type
setting 30

power save mode 24

print quality problems, solve 42

printing
demo page 20
reports 32

problem, solve
Linux 45
paper feeding 41
printing quality 42
Windows 45

R

replacing components
toner cartridge 35

reports, print 32

S

status LED 17

stop button 17

supplies
expected toner cartridge life 34

T

toner LED 17

tray
adjusting the width and length 28

U

using
SetIP 21

W

Windows problems 45

contact SAMSUNG worldwide

If you have any comments or questions regarding Samsung products, contact the Samsung customer care center.

COUNTRY	CUSTOMER CARE CENTER	WEB SITE
ARGENTINE	0800-333-3733	www.samsung.com/ar
AUSTRALIA	1300 362 603	www.samsung.com
AUSTRIA	0800-SAMSUNG (726-7864)	www.samsung.com/at
BELGIUM	0032 (0)2 201 24 18	www.samsung.com/be
BRAZIL	0800-124-421 4004-0000	www.samsung.com
CANADA	1-800-SAMSUNG (726-7864)	www.samsung.com/ca
CHILE	800-SAMSUNG (726-7864)	www.samsung.com/cl
CHINA	800-810-5858 010- 6475 1880	www.samsung.com.cn
COLOMBIA	01-8000-112-112	www.samsung.com/co
COSTA RICA	0-800-507-7267	www.samsung.com/latin
CZECH REPUBLIC	844 000 844 Distributor pro Českou republiku : Samsung Zrt., česká organizační složka Vyskočilova 4, 14000 Praha 4	www.samsung.com/cz
DENMARK	70 70 19 70	www.samsung.com/dk
ECUADOR	1-800-10-7267	www.samsung.com/latin
EL SALVADOR	800-6225	www.samsung.com/latin
ESTONIA	800-7267	www.samsung.ee
KAZAHSTAN	8-10-800-500-55-500	www.samsung.kz
KYRGYZSTAN	00-800-500-55-500	
FINLAND	030-6227 515	www.samsung.com/fi
FRANCE	3260 SAMSUNG 08 25 08 65 65 (€ 0,15/min)	www.samsung.com
GERMANY	01805 - SAMSUNG (726- 7864 (€ 0,14/Min)	www.samsung.com
GUATEMALA	1-800-299-0013	www.samsung.com/latin
HONDURAS	800-7919267	
HONG KONG	3698-4698	www.samsung.com/hk
HUNGARY	06-80-SAMSUNG (726-7864)	www.samsung.com
INDIA	3030 8282 1800 110011	www.samsung.com

COUNTRY	CUSTOMER CARE CENTER	WEB SITE
INDONESIA	0800-112-8888	www.samsung.com
ITALIA	800-SAMSUNG (726-7864)	www.samsung.com
JAMAICA	1-800-234-7267	www.samsung.com/latin
JAPAN	0120-327-527	www.samsung.com/jp
LATVIA	800-7267	www.samsung.com/lv
LITHUANIA	8-800-77777	www.samsung.com/lt
LUXEMBURG	0035 (0)2 261 03 710	www.samsung.com/be
MALAYSIA	1800-88-9999	www.samsung.com/my
MEXICO	01-800-SAMSUNG (726- 7864)	www.samsung.com
NETHERLANDS	0900-SAMSUNG (726-7864 € 0,10/Min)	www.samsung.com/nl
NEW ZEALAND	0800SAMSUNG (726-7864)	www.samsung.com/nz
NICARAGUA	00-1800-5077267	
NORWAY	815-56 480	www.samsung.com/no
PANAMA	800-7267	www.samsung.com/latin
PHILIPPINES	1800-10-SAMSUNG (726- 7864)	www.samsung.com/ph
POLAND	0 801 801 881 022-607-93-33	www.samsung.com/pl
PORTUGAL	80820-SAMSUNG (726-7864)	www.samsung.com/pt
PUERTO RICO	1-800-682-3180	www.samsung.com/latin
REP. DOMINICA	1-800-751-2676	www.samsung.com/latin
EIRE	0818 717 100	www.samsung.com/ie
RUSSIA	8-800-555-55-55	www.samsung.com
SINGAPORE	1800-SAMSUNG (726-7864)	www.samsung.com/sg
SLOVAKIA	0800-SAMSUNG (726-7864)	www.samsung.com/sk
SOUTH AFRICA	0860-SAMSUNG (726-7864)	www.samsung.com
SPAIN	902 10 11 30	www.samsung.com
SWEDEN	0771-400 200	www.samsung.com/se

COUNTRY	CUSTOMER CARE CENTER	WEB SITE
SWITZERLAND	0800-SAMSUNG (726-7864)	www.samsung.com/ch
TADJIKISTAN	8-10-800-500-55-500	
TAIWAN	0800-329-999	www.samsung.com
THAILAND	1800-29-3232 02-689-3232	www.samsung.com/th
TRINIDAD & TOBAGO	1-800-SAMSUNG (726-7864)	www.samsung.com/latin
TURKEY	444 77 11	www.samsung.com
U.A.E	800-SAMSUNG (726-7864) 8000-4726	www.samsung.com
U.K	0845 SAMSUNG (726-7864)	www.samsung.com
U.S.A.	1-800-SAMSUNG (726-7864)	www.samsung.com/us
UKRAINE	8-800-502-0000	www.samsung.com
UZBEKISTAN	8-10-800-500-55-500	www.samsung.com.uz
VENEZUELA	0-800-100-5303	www.samsung.com/latin
VIETNAM	1 800 588 889	www.samsung.com

© 2008 Samsung Electronics Co., Ltd. All rights reserved.

This user's guide is provided for information purposes only. All information included herein is subject to change without notice. Samsung Electronics is not responsible for any direct or indirect damages, arising from or related to use of this user's guide.

- Samsung and Samsung logo are trademarks of Samsung Electronics Co., Ltd.
- Microsoft, Windows, and Windows Vista are either registered trademarks or trademarks of Microsoft Corporation.
- UFST® and MicroType™ are registered trademarks of Monotype Imaging Inc.
- TrueType, LaserWriter and Macintosh are trademarks of Apple Computer, Inc.
- All other brand or product names are trademarks of their respective companies or organizations.



Samsung Printer

Software section



SOFTWARE SECTION

CONTENTS

Chapter 1: **INSTALLING PRINTER SOFTWARE IN WINDOWS**

Installing Printer Software	4
Installing Software for Local Printing	4
Installing Software for Network Printing	7
Changing the Software Language	10
Reinstalling Printer Software	10
Removing Printer Software	11
Installing mono printer driver	11

Chapter 2: **BASIC PRINTING**

Printing a Document	13
Printing to a file (PRN)	14
Printer Settings	14
Layout Tab	15
Paper Tab	15
Graphics Tab	16
Extras Tab	17
About Tab	18
Printer Tab	18
Using a Favorite Setting	18
Using Help	18

Chapter 3: **ADVANCED PRINTING**

Printing Multiple Pages on One Sheet of Paper (N-Up Printing)	19
Printing Posters	20
Printing Booklets	20
Printing on Both Sides of Paper	21
Printing a Reduced or Enlarged Document	21

Fitting Your Document to a Selected Paper Size	21
Using Watermarks	22
Using an Existing Watermark	22
Creating a Watermark	22
Editing a Watermark	22
Deleting a Watermark	22
Using Overlays	23
What is an Overlay?	23
Creating a New Page Overlay	23
Using a Page Overlay	23
Deleting a Page Overlay	23

Chapter 4: SHARING THE PRINTER LOCALLY

Setting Up a Host Computer	24
Setting Up a Client Computer	24

Chapter 5: USING SMART PANEL

Understanding Smart Panel	25
Opening the Troubleshooting Guide	26
Using Printer Settings Utility	26
Using Onscreen Help File	26
Changing the Smart Panel Program Settings	26

Chapter 6: USING YOUR PRINTER IN LINUX

Getting Started	27
Installing the Unified Linux Driver	27
Installing the Unified Linux Driver	27
Uninstalling the Unified Linux Driver	28
Using SetIP program	29
Starting the program	29
Using the Unified Driver Configurator	29
Opening the Unified Driver Configurator	29
Printers Configuration	30
Ports Configuration	30

Configuring Printer Properties	31
Printing a Document	31
Printing from Applications	31
Printing Files	32

Chapter 7: USING YOUR PRINTER WITH A MACINTOSH

Installing Software	33
Using SetIP program	34
Setting Up the Printer	34
For a Network-connected	34
For a USB-connected	35
Printing	36
Printing a Document	36
Changing Printer Settings	36
Printing Multiple Pages on One Sheet of Paper	38

1 Installing Printer Software in Windows

This chapter includes:

- **Installing Printer Software**
- **Changing the Software Language**
- **Reinstalling Printer Software**
- **Removing Printer Software**
- **Installing mono printer driver**

NOTE: The following procedure is based on Windows XP, for other operating systems, refer to the corresponding Windows user's guide or online help.

Installing Printer Software

You can install the printer software for local printing or network printing. To install the printer software on the computer, perform the appropriate installation procedure depending on the printer in use.

A printer driver is software that lets your computer communicate with your printer. The procedure to install drivers may differ depending on the operating system you are using.

All applications should be closed on your PC before beginning installation.

Installing Software for Local Printing

A local printer is a printer directly attached to your computer using the printer cable supplied with your printer, such as a USB or parallel cable. If your printer is attached to a network, skip this step and go to "Installing Software for Network Printing" on page 7.

You can install the printer software using the typical or custom method.

NOTE: If the "New Hardware Wizard" window appears during the installation procedure, click  in the upper right corner of the box to close the window, or click **Cancel**.

Typical Installation

This is recommended for most users. All components necessary for printer operations will be installed.

- 1 Make sure that the printer is connected to your computer and powered on.
- 2 Insert the supplied CD-ROM into your CD-ROM drive. The CD-ROM should automatically run, and an installation window appears. If the installation window does not appear, click **Start** and then **Run**. Type **X:\Setup.exe**, replacing "X" with the letter which represents your drive and click **OK**. If you use Windows Vista, click **Start** → **All programs** → **Accessories** → **Run**, and type **X:\Setup.exe**. If the **AutoPlay** window appears in Windows Vista, click **Run Setup.exe** in **Install or run program** field, and click **Continue** in the **User Account Control** window.
- 3 Click **Next**.

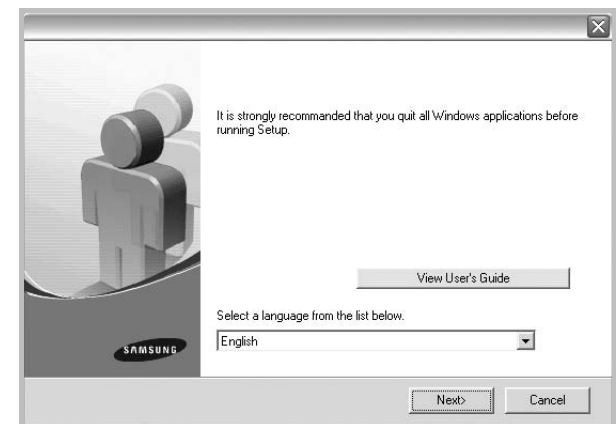

- If necessary, select a language from the drop-down list.
 - **View User's Guide:** Allows you to view the User's Guide. If your computer doesn't have Adobe Acrobat, click on this option and it will automatically install Adobe Acrobat Reader for you.
- 4 Select **Typical installation for a local printer**. Click **Next**.

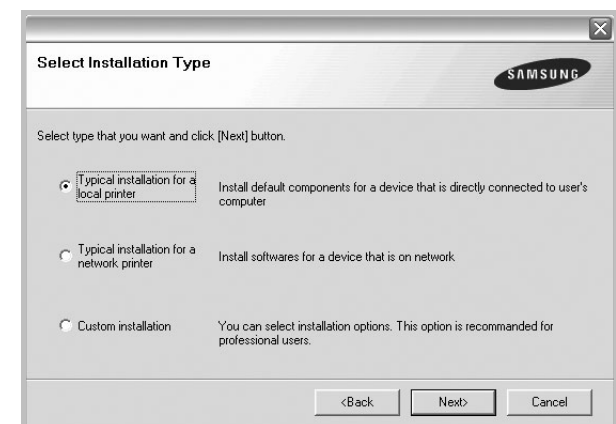

NOTE: If your printer is not already connected to the computer, the following window will appear.

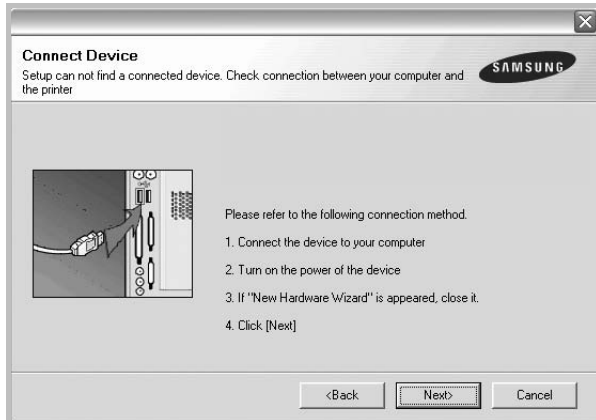

- After connecting the printer, click **Next**.
- If you don't want to connect the printer at this time, click **Next**, and **No** on the following screen. Then the installation will start and a test page will not be printed at the end of the installation.
- *The installation window that appears in this User's Guide may differ depending on the printer and interface in use.*

- 5 After the installation is finished, a window asking you to print a test page appears. If you choose to print a test page, select the checkbox and click **Next**. Otherwise, just click **Next** and skip to step 7.
- 6 If the test page prints out correctly, click **Yes**. If not, click **No** to reprint it.
- 7 To register yourself as a user of Samsung Printers in order to receive information from Samsung, select the checkbox and click **Finish**. You are now sent to the Samsung web site.

Otherwise, just click **Finish**.



NOTE: After setup is complete, if your printer driver doesn't work properly, reinstall the printer driver. See "Reinstalling Printer Software" on page 10.

Custom Installation

You can choose individual components to install.

- 1 Make sure that the printer is connected to your computer and powered on.
- 2 Insert the supplied CD-ROM into your CD-ROM drive. The CD-ROM should automatically run, and an installation window appears. If the installation window does not appear, click **Start** and then **Run**. Type **X:\Setup.exe**, replacing "X" with the letter which represents your drive and click **OK**. If you use Windows Vista, click **Start** → **All programs** → **Accessories** → **Run**, and type **X:\Setup.exe**. If the **AutoPlay** window appears in Windows Vista, click **Run Setup.exe** in **Install or run program** field, and click **Continue** in the **User Account Control** window.
- 3 Click **Next**.

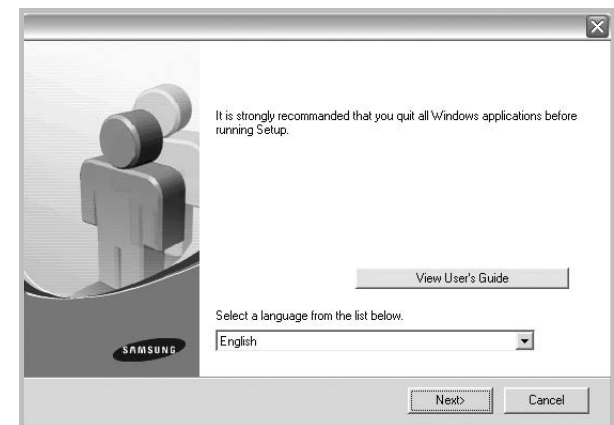

- If necessary, select a language from the drop-down list.
- **View User's Guide:** Allows you to view the User's Guide. If your computer doesn't have Adobe Acrobat, click on this option and it will automatically install Adobe Acrobat Reader for you.

- 4 Select **Custom installation**. Click **Next**.

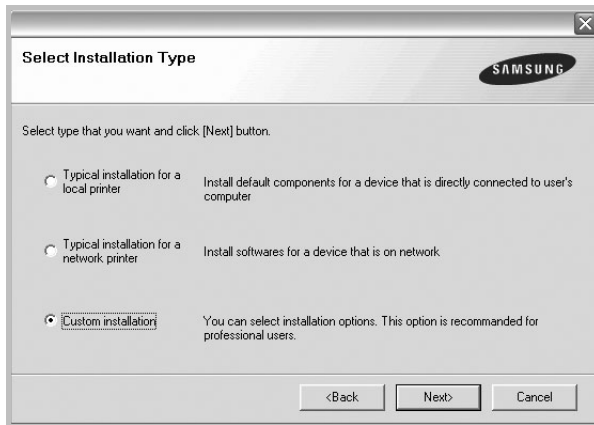

- 5 Select your printer and click **Next**.



NOTE: If your printer is not already connected to the computer, the following window will appear.

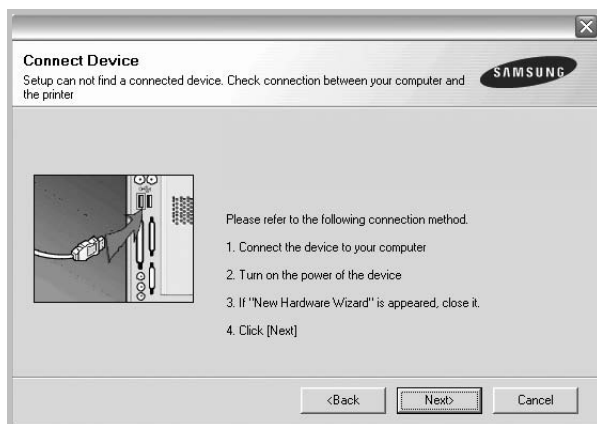

- After connecting the printer, click **Next**.
- If you don't want to connect the printer at this time, click **Next**, and **No** on the following screen. Then the installation will start and a test page will not be printed at the end of the installation.

• *The installation window that appears in this User's Guide may differ depending on the printer and interface in use.*

- 6 Select the components to be installed and click **Next**.

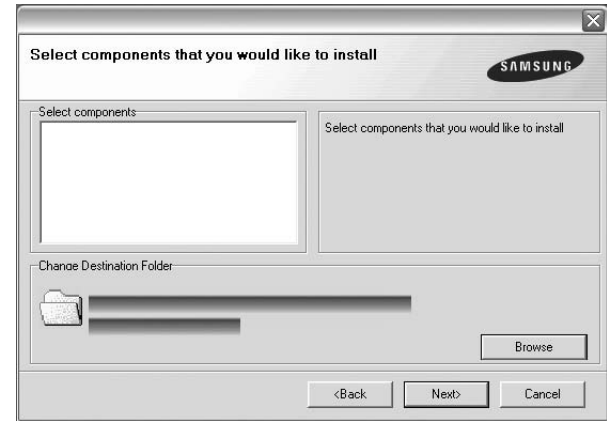

NOTE: You can change the desired installation folder by clicking [**Browse**].

- 7 After the installation is finished, a window asking you to print a test page appears. If you choose to print a test page, select the checkbox and click **Next**. Otherwise, just click **Next** and skip to step 9.
- 8 If the test page prints out correctly, click **Yes**. If not, click **No** to reprint it.
- 9 To register yourself as a user of Samsung Printers in order to receive information from Samsung, select the checkbox and click **Finish**. You are now sent to the Samsung web site. Otherwise, just click **Finish**.

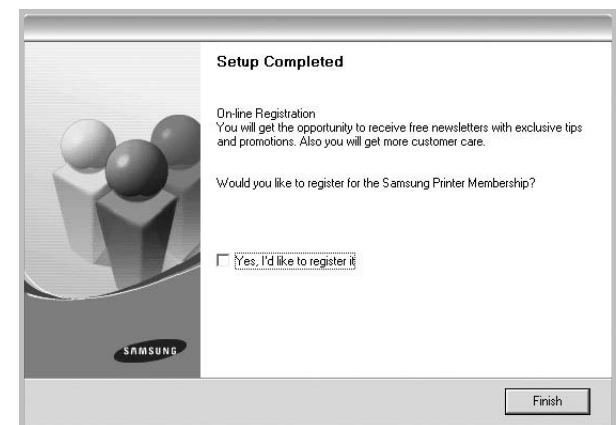

Installing Software for Network Printing

When you connect your printer to a network, you must first configure the TCP/IP settings for the printer. After you have assigned and verified the TCP/IP settings, you are ready to install the software on each computer on the network.

You can install the printer software using the typical or custom method.

Typical Installation

This is recommended for most users. All components necessary for printer operations will be installed.

- 1 Make sure that the printer is connected to your network and powered on. For details about connecting to the network, see the supplied printer's User's Guide.
- 2 Insert the supplied CD-ROM into your CD-ROM drive. The CD-ROM should automatically run, and an installation window appears. If the installation window does not appear, click **Start** and then **Run**. Type **X:\Setup.exe**, replacing "X" with the letter which represents your drive and click **OK**. If you use Windows Vista, click **Start** → **All programs** → **Accessories** → **Run**, and type **X:\Setup.exe**. If the **AutoPlay** window appears in Windows Vista, click **Run Setup.exe** in **Install or run program** field, and click **Continue** in the **User Account Control** window.
- 3 Click **Next**.

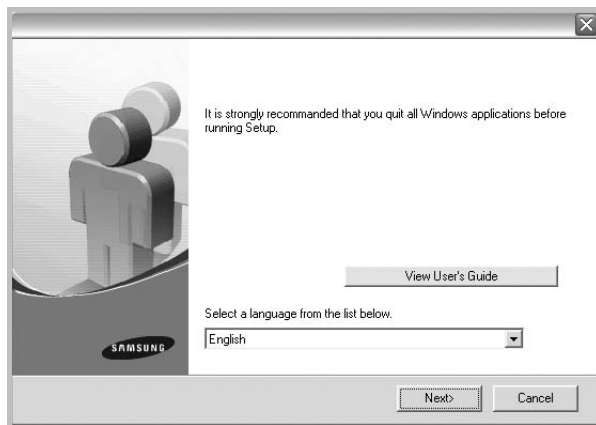

- If necessary, select a language from the drop-down list.
- **View User's Guide:** Allows you to view the User's Guide. If your computer doesn't have Adobe Acrobat, click on this option and it will automatically install Adobe Acrobat Reader for you.

- 4 Select **Typical installation for a network printer**. Click **Next**.

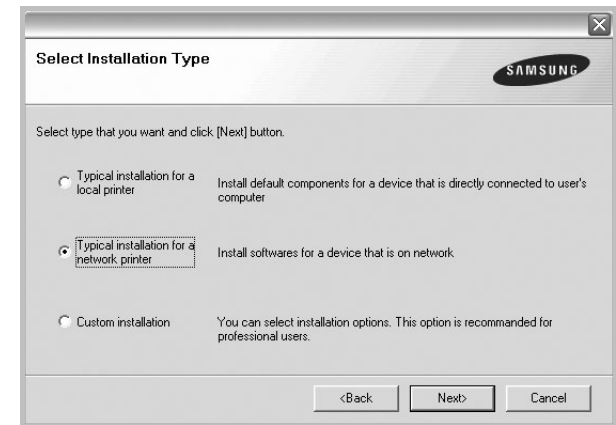

NOTE: If your printer is not connected to the network, the following window will appear. Select a setup option you want, click **Next**.

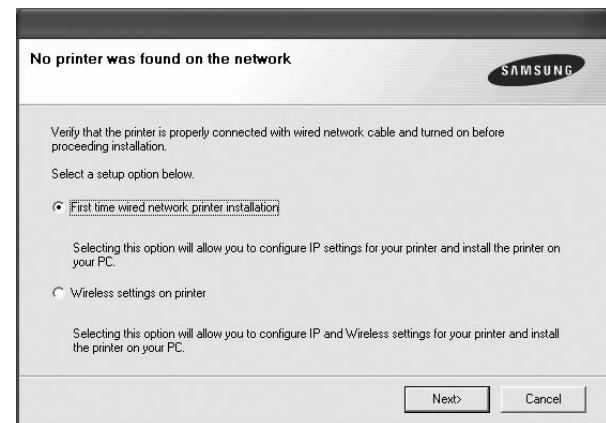

Then the **Set IP Address** window appears. Do as follows:

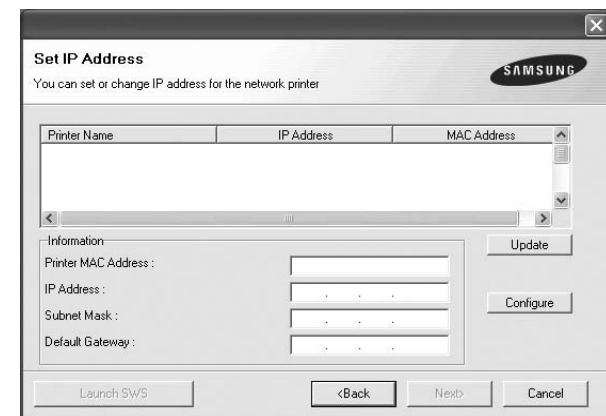

1. Select a printer to be set with a specific IP address from the list.

2. Configure an IP address, subnet mask, and gateway for the printer manually and click **Configure** to set the specific IP address for the network printer.
3. Click **Next**, and go to step to step 6.
 - You can also set the network printer via SyncThru™ Web Service, an embedded web server. Click **Launch SWS** on **Set IP Address** window. Your machine's embedded website opens.

- 5 The list of printers available on the network appears. Select the printer you want to install from the list and then click **Next**.

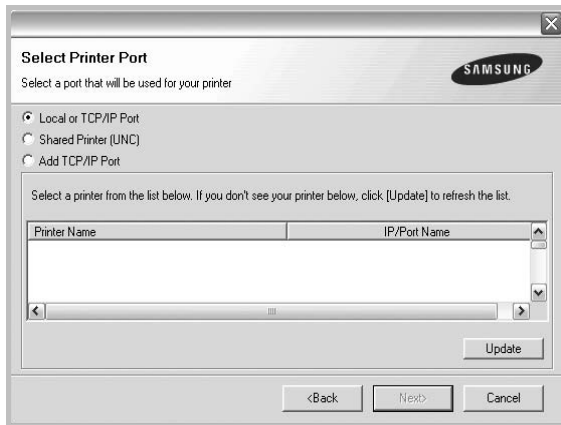

- If you do not see your printer on the list, click **Update** to refresh the list, or select **Add TCP/IP Port** to add your printer to the network. To add the printer to the network, enter the port name and the IP address for the printer.

To verify your printer's IP address or the MAC address, print a Network Configuration page.

- To find a shared network printer (UNC Path), select **Shared Printer [UNC]** and enter the shared name manually or find a shared printer by clicking the **Browse** button.

NOTE: If you cannot find your machine in network, please turn off the firewall and click **Update**.

For Windows operating system, **Start** → **Control Panel** and start windows firewall, and set this option unactivated. For other operating system, refer to its on-line guide.

- 6 After the installation is finished, a window appears asking you to print a test page and to register yourself as a user of Samsung Printers in order to receive information from Samsung. If you so desire, select the corresponding checkbox(es) and click **Finish**.

Otherwise, just click **Finish**.



NOTE: After setup is complete, if your printer driver doesn't work properly, reinstall the printer driver. See "Reinstalling Printer Software" on page 10.

Custom Installation

You can choose individual components to install and set a specific IP address.

- 1 Make sure that the printer is connected to your network and powered on. For details about connecting to the network, see the supplied printer's User's Guide.
- 2 Insert the supplied CD-ROM into your CD-ROM drive. The CD-ROM should automatically run, and an installation window appears.
 - If the installation window does not appear, click **Start** and then **Run**. Type **X:\Setup.exe**, replacing "X" with the letter which represents your drive and click **OK**.
 - If you use Windows Vista, click **Start** → **All programs** → **Accessories** → **Run**, and type **X:\Setup.exe**.
 - If the **AutoPlay** window appears in Windows Vista, click **Run Setup.exe** in **Install or run program** field, and click **Continue** in the **User Account Control** window.

3 Click **Next**.

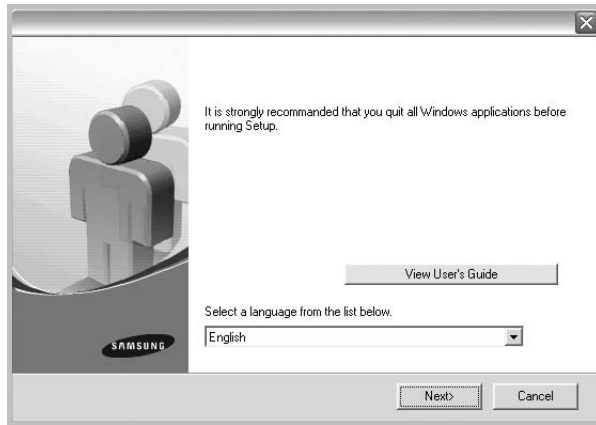

- If necessary, select a language from the drop-down list.
- **View User's Guide:** Allows you to view the User's Guide. If your computer doesn't have Adobe Acrobat, click on this option and it will automatically install Adobe Acrobat Reader for you.

4 Select **Custom installation**. Click **Next**.



5 The list of printers available on the network appears. Select the printer you want to install from the list and then click **Next**.

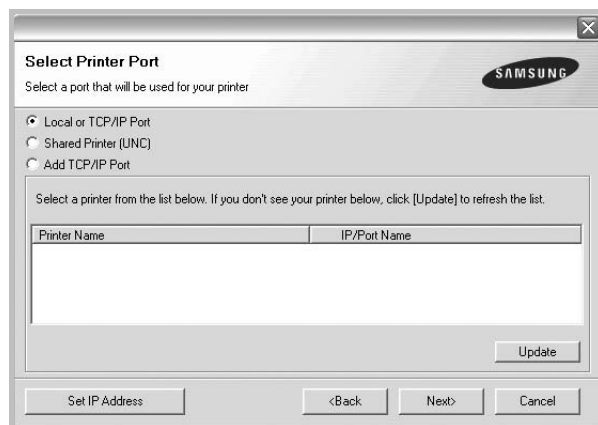

- If you do not see your printer on the list, click **Update** to refresh the list, or select **Add TCP/IP Port** to add your printer to the network. To add the printer to the network, enter the port name and the IP address for the printer.

To verify your printer's IP address or the MAC address, print a Network Configuration page.

- To find a shared network printer (UNC Path), select **Shared Printer [UNC]** and enter the shared name manually or find a shared printer by clicking the **Browse** button.

NOTE: If you cannot find your machine in network, please turn off the firewall and click **Update**.

For Windows operating system, **Start** → **Control Panel** and start windows firewall, and set this option unactivated. For other operating system, refer to its on-line guide.

TIP: If you want to set a specific IP address on a specific network printer, click the **Set IP Address** button. The Set IP Address window appears. Do as follows:

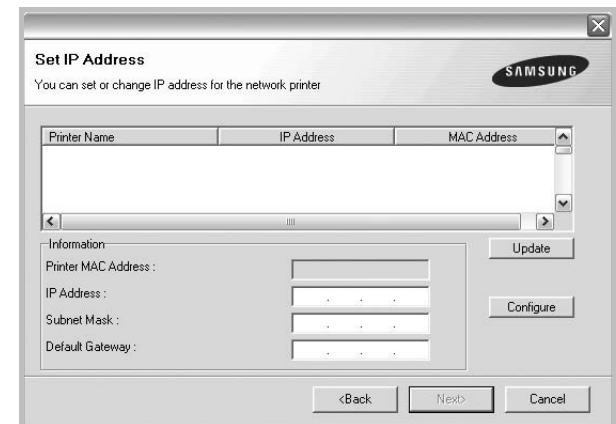

- a. Select a printer to be set with a specific IP address from the list.
- b. Configure an IP address, subnet mask, and gateway for the printer manually and click **Configure** to set the specific IP address for the network printer.
- c. Click **Next**.

- You can also set the network printer via SyncThru™ Web Service, an embedded web server. Click **Launch SWS** on **Set IP Address** window. Your machine's embedded website opens.

6 Select the components to be installed. After selecting the components, the following window appears. You can also change the printer name, set the printer to be shared on

the network, set the printer as the default printer, and change the port name of each printer. Click **Next**.

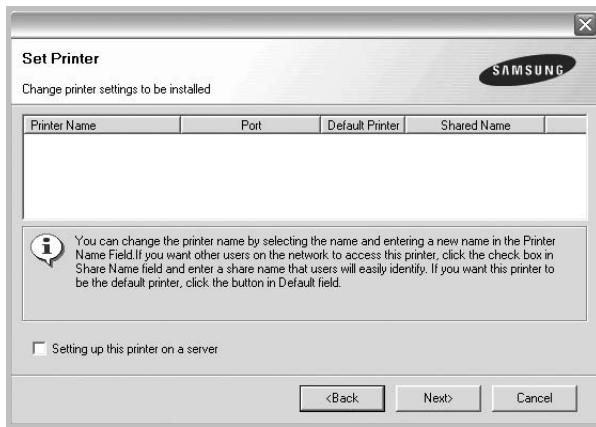

To install this software on a server, select the **Setting up this printer on a server** checkbox.

- 7 After the installation is finished, a window appears asking you to print a test page and to register yourself as a user of Samsung Printers in order to receive information from Samsung. If you so desire, select the corresponding checkbox(es) and click **Finish**.

Otherwise, just click **Finish**.

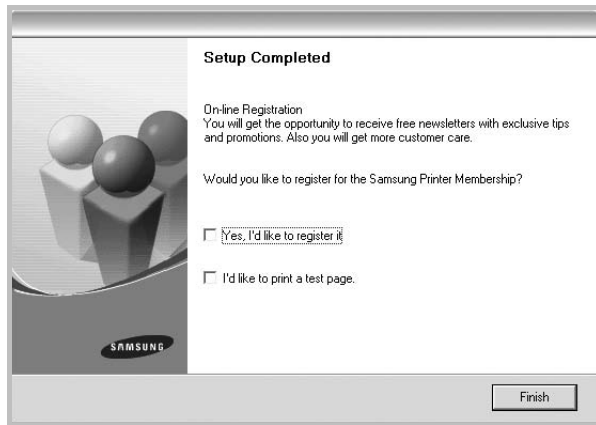

NOTE: After setup is complete, if your printer driver doesn't work properly, reinstall the printer driver. See "Reinstalling Printer Software" on page 10.

Changing the Software Language

After installation of the software, you can change the display language.

- 1 Click the Windows **Start** menu.
- 2 Select **Programs** or **All Programs** and then **your printer driver name**.
- 3 Select **Language Selection**.
- 4 Select the desired language from the language selection window, and click **OK**.

Reinstalling Printer Software

You can reinstall the software if installation fails.

- 1 Start Windows.
- 2 From the **Start** menu select **Programs** or **All Programs** → **your printer driver name** → **Maintenance**.
- 3 Select **Repair** and click **Next**.
- 4 The list of printers available on the network appears. Select the printer you want to install from the list and then click **Next**.

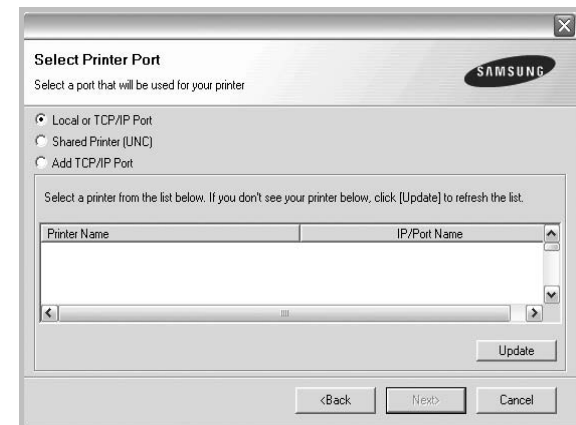

- If you do not see your printer on the list, click **Update** to refresh the list, or select **Add TCP/IP Port** to add your printer to the network. To add the printer to the network, enter the port name and the IP address for the printer.
- To find a shared network printer (UNC Path), select **Shared Printer [UNC]** and enter the shared name manually or find a shared printer by clicking the **Browse** button.

You will see a component list so that you can reinstall any item individually.

NOTE: If your printer is not already connected to the computer, the following window will appear.

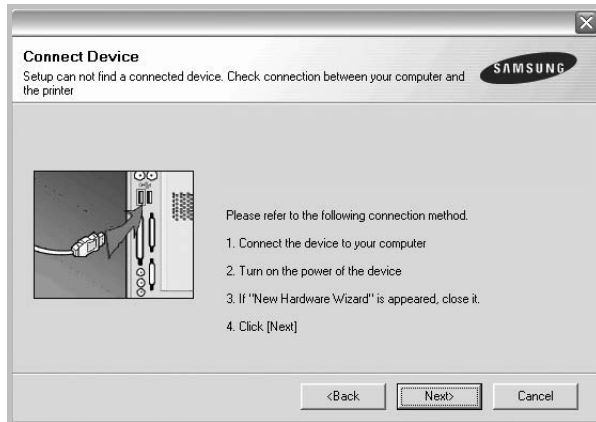

- After connecting the printer, click **Next**.
- If you don't want to connect the printer at this time, click **Next**, and **No** on the following screen. Then the installation will start and a test page will not be printed at the end of the installation.
- *The reinstallation window that appears in this User's Guide may differ depending on the printer and interface in use.*

- 5 Select the components you want to reinstall and click **Next**.

If you installed the printer software for local printing and you select **your printer driver name**, the window asking you to print a test page appears. Do as follows:

- a. To print a test page, select the check box and click **Next**.
 - b. If the test page prints out correctly, click **Yes**.
If it doesn't, click **No** to reprint it.
- 6 When the reinstallation is done, click **Finish**.

Removing Printer Software

- 1 Start Windows.
- 2 From the **Start** menu select **Programs** or **All Programs** → **your printer driver name** → **Maintenance**.
- 3 Select **Remove** and click **Next**.
You will see a component list so that you can remove any item individually.
- 4 Select the components you want to remove and then click **Next**.
- 5 When your computer asks you to confirm your selection, click **Yes**.
The selected driver and all of its components are removed from your computer.
- 6 After the software is removed, click **Finish**.

Installing mono printer driver

This printer provides you the printer drivers with a mono driver so you can use your printer as a monochrome printer. You must install the mono driver on your computer. Following steps guide you through the step by step installation process.

- 1 Make sure that the printer is connected to your computer and powered on. Or your computer and printer are connected to the network.
- 2 Insert the supplied CD-ROM into your CD-ROM drive. The CD-ROM should automatically run, and an installation window appears.
- 3 Click **Cancel**.

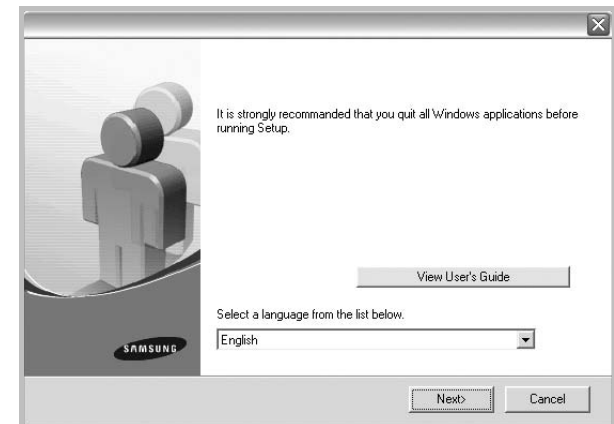

If the confirmation window appears, click **Finish**.

- 4 Click **Start** → **Printers and Faxes**.
- 5 Select **Add Printer**.
- 6 When **Add Printer Wizard** appears, click **Next**.
- 7 Select **Local printer attached to this computer**, and **Automatically detect and install my Plug and Play printer**, then click **Next**. Go to step 13.
If your computer does not find the printer, then follow the next step.
- 8 Select **Next** in the **Select a Printer Port** window.
- 9 In the **Select a Printer Port** window, select **Have Disk...**
- 10 Click **Browse** to find a mono driver for your printer.
ex) Windows XP 32 bit
Select CD-ROM drive → **Printer** → **SPL_MONO** → **WINXP_2000_VISTA-32**
- 11 Select *****.inf** file and click **Open**.
- 12 Click **OK** in the **Install From Disk** window.
- 13 Select a mono driver in the **Printers** field, and click **Next**.

NOTE: If you have installed a mono driver before, then the **Use Existing Driver** window. Select as the window explains, and click **Next**. Also, depending on your computer configuration, the printer sharing window or the print the test page window may appear; make the appropriate selection.

14 Enter your printer name, and click **Next**.

15 Click **Finish** to start installing a mono printer driver.

NOTE: If your printer is connected to a network, go to printer's **Properties** and select the **Ports** tab, then click **Add Port** and **Standard TCP/IP Port**, and create a new port to connect to the printer. To create a new port, follow the procedure laid out in the wizard window.

2 Basic Printing



This chapter explains the printing options and common printing tasks in Windows.

This chapter includes:

- **Printing a Document**
- **Printing to a file (PRN)**
- **Printer Settings**
 - **Layout Tab**
 - **Paper Tab**
 - **Graphics Tab**
 - **Extras Tab**
 - **About Tab**
 - **Printer Tab**
 - **Using a Favorite Setting**
 - **Using Help**

Printing a Document

NOTES:

- Your printer driver **Properties** window that appears in this User's Guide may differ depending on the printer in use. However the composition of the printer properties window is similar.
- **Check the Operating System(s) that are compatible with your printer. Please refer to the OS Compatibility section of Printer Specifications in your Printer User's Guide.**
- If you need to know the exact name of your printer, you can check the supplied CD-ROM.
- When you select an option in printer properties, you may see an exclamation mark  or a crossed-out mark . An exclamation mark means you can select that certain option but it is not recommended, and a crossed-out mark means you cannot select that option due to the machine's setting or environment.

The following procedure describes the general steps required for printing from various Windows applications. The exact steps for printing a document may vary depending on the application program you are using. Refer to the User's Guide of your software application for the exact printing procedure.

- 1 Open the document you want to print.
- 2 Select **Print** from the **File** menu. The Print window is displayed. It may look slightly different depending on your application.

The basic print settings are selected within the Print window. These settings include the number of copies and print range.

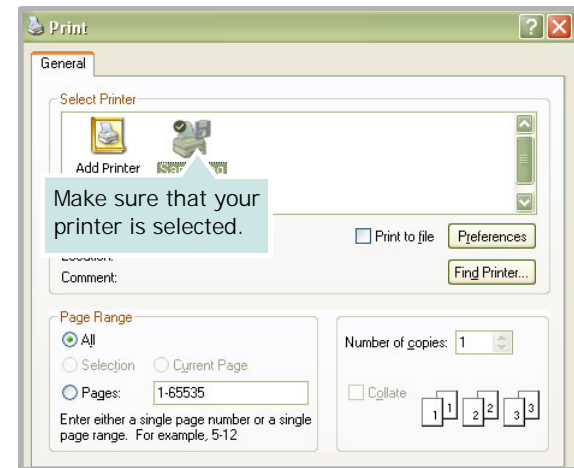

- 3 Select **your printer driver** from the **Name** drop-down list.

To take advantage of the printer features provided by your printer driver, click **Properties** or **Preferences** in the application's Print window. For details, see "Printer Settings" on page 14.

If you see **Setup**, **Printer**, or **Options** in your Print window, click it instead. Then click **Properties** on the next screen.

Click **OK** to close the printer properties window.

- 4 To start the print job, click **OK** or **Print** in the Print window.

Printing to a file (PRN)

You will sometimes need to save the print data as a file for your purpose.

To create a file:

- 1 Check the **Print to file** box at the **Print** window.

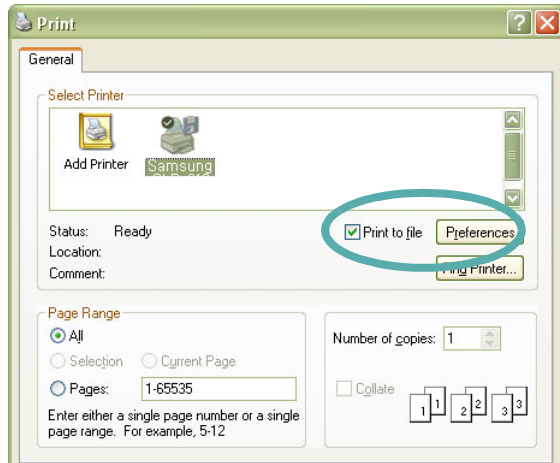

- 2 Select the folder and assign a name of the file and then click OK.

Printer Settings

You can use the printer properties window, which allows you to access all of the printer options you need when using your printer. When the printer properties are displayed, you can review and change the settings needed for your print job.

Your printer properties window may differ, depending on your operating system. This Software User's Guide shows the Properties window for Windows XP.

Your printer driver **Properties** window that appears in this User's Guide may differ depending on the printer in use.

If you access printer properties through the Printers folder, you can view additional Windows-based tabs (refer to your Windows User's Guide) and the Printer tab (see "Printer Tab" on page 18).

NOTES:

- Most Windows applications will override settings you specify in the printer driver. Change all print settings available in the software application first, and change any remaining settings using the printer driver.
- The settings you change remain in effect only while you are using the current program. **To make your changes permanent**, make them in the Printers folder.
- The following procedure is for Windows XP. For other Windows OS, refer to the corresponding Windows User's Guide or online help.
 1. Click the Windows **Start** button.
 2. Select **Printers and Faxes**.
 3. Select **your printer driver icon**.
 4. Right-click on the printer driver icon and select **Printing Preferences**.
 5. Change the settings on each tab, click OK.

Layout Tab

The **Layout** tab provides options to adjust how the document appears on the printed page. The **Layout Options** includes **Multiple Pages per Side**, **Poster Printing** and **Booklet Printing**. See “Printing a Document” on page 13 for more information on accessing printer properties.

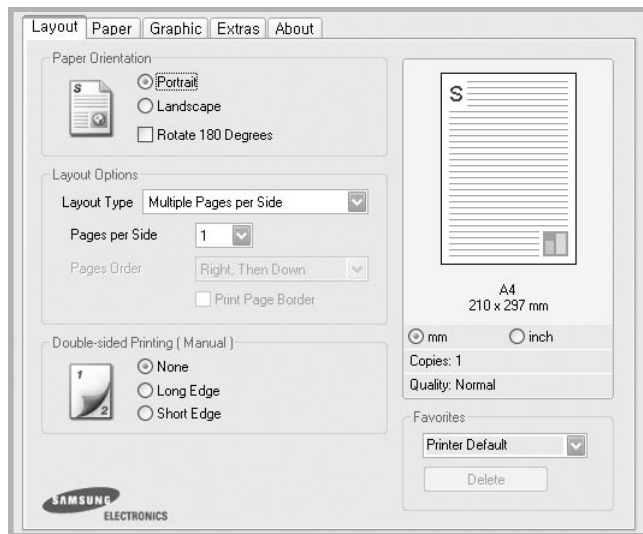

Paper Orientation

Paper Orientation allows you to select the direction in which information is printed on a page.

- **Portrait** prints across the width of the page, letter style.
- **Landscape** prints across the length of the page, spreadsheet style.
- **Rotate 180 Degrees** allows you to rotate the page, 180 degrees.

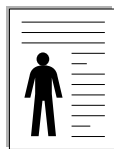

▲ Portrait

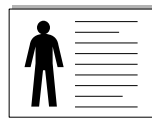

▲ Landscape

Layout Options

Layout Options allows you to select advanced printing options. You can choose **Multiple Pages per Side** and **Poster Printing**.

- For details, see “Printing Multiple Pages on One Sheet of Paper (N-Up Printing)” on page 19.
- For details, see “Printing Posters” on page 20
- For details, see “Printing Booklets” on page 20

Double-sided Printing

Double-sided Printing allows you to print on both sides of paper. *If this option does not appear, your printer does not have this feature.*

- For details, see “Printing on Both Sides of Paper” on page 21.

Paper Tab

Use the following options to set the basic paper handling specifications when you access the printer properties. See “Printing a Document” on page 13 for more information on accessing printer properties.

Click the **Paper** tab to access various paper properties.

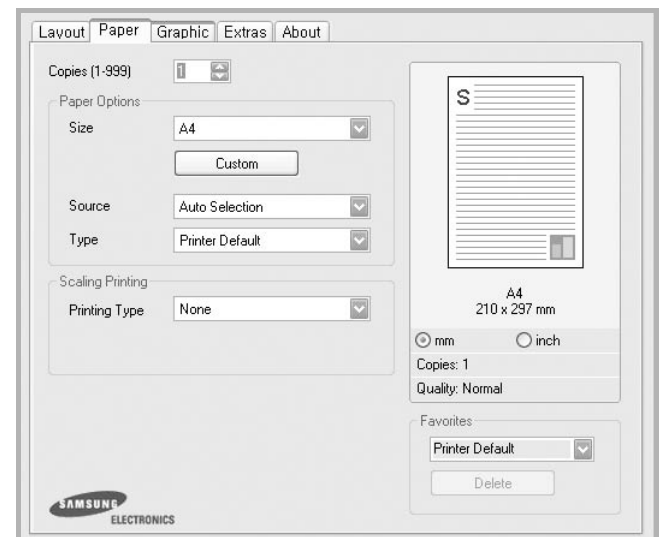

Copies

Copies allows you to choose the number of copies to be printed. You can select 1 to 999 copies.

Paper Options

Size

Size allows you to set the size of paper you loaded in the tray. If the required size is not listed in the **Size** box, click **Custom**. When the **Custom Paper Setting** window appears, set the paper size and click **OK**. The setting appears in the list so that you can select it.

Source

Make sure that **Source** is set to the corresponding paper tray. Use **Manual Feeder** when printing on special materials like envelopes and transparencies.

Type

Set **Type** to correspond to the paper loaded in the tray from which you want to print. This will let you get the best quality printout. If not, print quality may not be achieved as you want.

Thick Paper: 24 lb to 28 lb (90~105 g/m²) thick paper.

Thin Paper: 16 lb to 19 lb (60~70 g/m²) thin paper.

Cotton: 20 lb to 24 lb (75~90 g/m²) cotton paper such as Gilbert 25 % and Gilbert 100 %.

Plain Paper: Normal plain paper. Select this type if your printer is monochrome and printing on the 16 lb (60 g/m²) cotton paper.

Recycled Paper: 20 lb to 24 lb (75~90 g/m²) recycled paper.

Color Paper: 20 lb to 24 lb (75~90 g/m²) color-background paper.

Archive Paper: If you need to keep print-out for a long period time such as archives, select this option.

Glossy Photo 160 g/m² (Glossy Photo 44 lb): 44 lb (160 g/m²) glossy paper.

Scaling Printing

Scaling Printing allows you to automatically or manually scale your print job on a page. You can choose from **None**, **Reduce/Enlarge**, and **Fit to Page**.

- For details, see "Printing a Reduced or Enlarged Document" on page 21.
- For details, see "Fitting Your Document to a Selected Paper Size" on page 21.

Graphics Tab

Use the following Graphic options to adjust the print quality for your specific printing needs. See "Printing a Document" on page 13 for more information on accessing printer properties.

Click the **Graphic** tab to display the properties shown below.

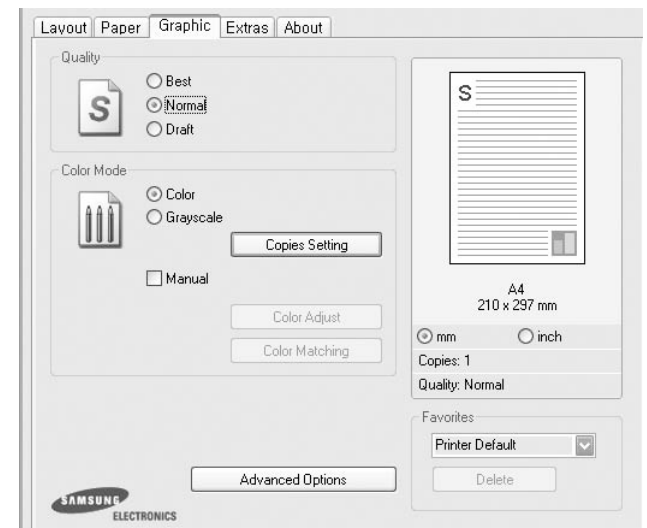

Quality

The Quality options you can select may vary depending on your printer model. The higher the setting, the sharper the clarity of printed characters and graphics. The higher setting also may increase the time it takes to print a document.

Color Mode

You can choose color options. Setting to **Color** typically produces the best possible print quality for color documents. If you want to print a color document in grayscale, select **Grayscale**. If you want to adjust the color options manually, select **Manual** and click the **Color Adjust** or **Color Matching** button.

- **Copies Setting:** In order to use this option, first you need to set total number of copies from **Paper** tab. When you make several copies, and if you want to print some copies in color and some in grayscale, use this option and select the number of copies in grayscale.
- **Color Adjust:** You can adjust the appearance of images by changing the settings in the **Levels** option.
- **Color Matching:** You can adjust the appearance of images by changing the settings in the **Settings** option.

Advanced Options

You can set advanced settings by clicking the **Advanced Options** button.

- **Print All Text To Black:** When the **Print All Text To Black** option is checked, all text in your document prints solid black, regardless of the color it appears on the screen.
- **Print All Text To Darken:** When the **Print All Text To Darken** option is checked, all text in your document is allowed to print darker than on a normal document. *Some printers do not support this feature.*
- **Grayscale Enhancement:** Press the **Smart Color** tab. It allows users to preserve the details of nature photos, and improve contrast and readability among gray scaled colors, when printing color documents in grayscale.
- **Fine Edge:** Press the **Smart Color** tab. It allows users to emphasize edges of texts and fine lines for improving readability and align each color channel registration in color printing mode.

Extras Tab

You can select output options for your document. See “Printing a Document” on page 13 for more information about accessing the printer properties.

Click the **Extras** tab to access the following feature:

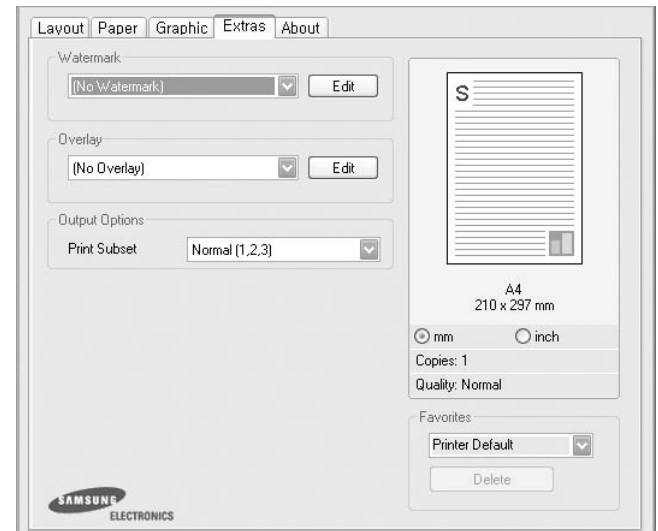

Watermark

You can create a background text image to be printed on each page of your document. For details, see “Using Watermarks” on page 22.

Overlay

Overlays are often used to take the place of preprinted forms and letterhead paper. For details, see “Using Overlays” on page 23.

Output Options

- **Print Subset:** You can set the sequence in which the pages print. Select the print order from the drop-down list.
 - **Normal (1,2,3):** Your printer prints all pages from the first page to the last page.
 - **Reverse All Pages (3,2,1):** Your printer prints all pages from the last page to the first page.
 - **Print Odd Pages:** Your printer prints only the odd numbered pages of the document.
 - **Print Even Pages:** Your printer prints only the even numbered pages of the document.

About Tab

Use the **About** tab to display the copyright notice and the version number of the driver. If you have an Internet browser, you can connect to the Internet by clicking on the web site icon. See "Printing a Document" on page 13 for more information about accessing printer properties.

Printer Tab

If you access printer properties through the **Printers** folder, you can view the **Printer** tab. You can set the printer configuration.

The following procedure is for Windows XP. For other Windows OS, refer to the corresponding Windows User's Guide or online help.

- 1 Click the Windows **Start** menu.
- 2 Select **Printers and Faxes**.
- 3 Select **your printer driver** icon.
- 4 Right-click on the printer driver icon and select **Properties**.
- 5 Click the **Printer** tab and set the options.

Using a Favorite Setting

The **Favorites** option, which is visible on each properties tab, allows you to save the current properties settings for future use.

To save a **Favorites** item:

- 1 Change the settings as needed on each tab.
- 2 Enter a name for the item in the **Favorites** input box.



- 3 Click **Save**.

When you save **Favorites**, all current driver settings are saved.

To use a saved setting, select the item from the **Favorites** drop down list. The printer is now set to print according to the Favorites setting you selected.

To delete a Favorites item, select it from the list and click **Delete**.

You can also restore the printer driver's default settings by selecting **Printer Default** from the list.

Using Help

Your printer has a help screen that can be activated by clicking the **Help** button in the printer properties window. These help screens give detailed information about the printer features provided by the printer driver.

You can also click  from the upper right corner of the window, and then click on any setting.

3 Advanced Printing

This chapter explains printing options and advanced printing tasks.

NOTE:

- Your printer driver **Properties** window that appears in this User's Guide may differ depending on the printer in use. However the composition of the printer properties window is similar.
 - If you need to know the exact name of your printer, you can check the supplied CD-ROM.
-

This chapter includes:

- **Printing Multiple Pages on One Sheet of Paper (N-Up Printing)**
- **Printing Posters**
- **Printing Booklets**
- **Printing on Both Sides of Paper**
- **Printing a Reduced or Enlarged Document**
- **Fitting Your Document to a Selected Paper Size**
- **Using Watermarks**
- **Using Overlays**

Printing Multiple Pages on One Sheet of Paper (N-Up Printing)



You can select the number of pages to print on a single sheet of paper. To print more than one page per sheet, the pages will be reduced in size and arranged in the order you specify. You can print up to 16 pages on one sheet.

- 1** To change the print settings from your software application, access printer properties. See “Printing a Document” on page 13.
- 2** From the **Layout** tab, choose **Multiple Pages per Side** in the **Layout Type** drop-down list.
- 3** Select the number of pages you want to print per sheet (1, 2, 4, 6, 9, or 16) in the **Pages per Side** drop-down list.
- 4** Select the page order from the **Page Order** drop-down list, if necessary.
Check **Print Page Border** to print a border around each page on the sheet.
- 5** Click the **Paper** tab, select the paper source, size, and type.
- 6** Click **OK** and print the document.

Printing Posters

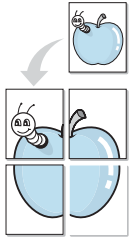

This feature allows you to print a single-page document onto 4, 9, or 16 sheets of paper, for the purpose of pasting the sheets together to form one poster-size document.

NOTE: The poster printing option is available when 600 dpi is selected in the resolution option on the Graphic tab.

- 1 To change the print settings from your software application, access printer properties. See “Printing a Document” on page 13.
- 2 Click the **Layout** tab, select **Poster Printing** in the **Layout Type** drop-down list.
- 3 Configure the poster option:

You can select the page layout from **Poster<2x2>**, **Poster<3x3>**, **Poster<4x4>** or **Custom**. If you select **Poster<2x2>**, the output will be automatically stretched to cover 4 physical pages. If the option is set to Custom, you can enlarge the original from 150% to 400%. Depending on the level of the enlargement, the page layout is automatically adjusted to **Poster<2x2>**, **Poster<3x3>**, **Poster<4x4>**.

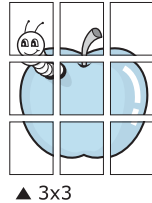
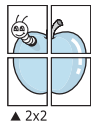

Specify an overlap in millimeters or inches to make it easier to pasting the sheets together.

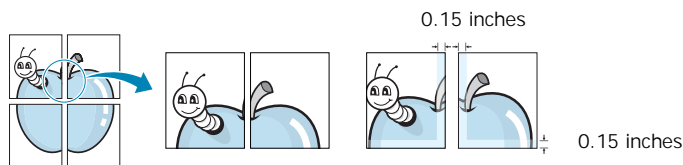

- 4 Click the **Paper** tab, select the paper source, size, and type.
- 5 Click **OK** and print the document. You can complete the poster by pasting the sheets together.

Printing Booklets

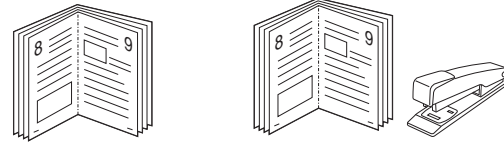

This printer feature allows you to print your document on both sides of the paper and arranges the pages so that the paper can be folded in half after printing to produce a booklet.

- 1 To change the print settings from your software application, access the printer properties. See “Printing a Document” on page 13.
- 2 From the **Layout** tab, choose **Booklet Printing** from the **Layout Type** drop-down list.

NOTE: The **Booklet Printing** option is not available for all paper sizes. In order to find out the available paper size for this feature, select the paper size in the **Size** option on the **Paper** tab, then check if the **Booklet Printing** in a **Layout Type** drop-down list on the **Layout** tab is activated.

- 3 Click the **Paper** tab, and select the paper source, size, and type.
- 4 Click **OK** and print the document.
- 5 After printing, fold and staple the pages.

Printing on Both Sides of Paper

You can print on both sides of a sheet of paper. Before printing, decide how you want your document oriented.

The options are:

- **None**
- **Long Edge**, which is the conventional layout used in book binding.
- **Short Edge**, which is the type often used with calendars.

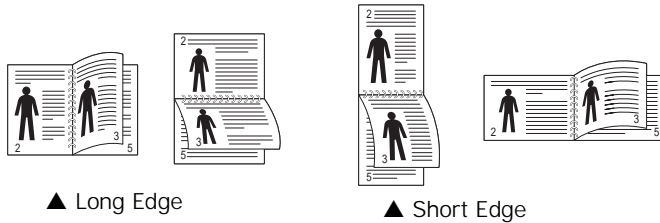

NOTE:

- Do not print on both sides of labels, transparencies, envelopes, or thick paper. Paper jamming and damage to the printer may result.

- 1 To change the print settings from your software application, access printer properties. “Printing a Document” on page 13.
- 2 From the **Layout** tab, select the paper orientation.
- 3 From the **Double-sided Printing** section, select the binding option you want.
- 4 Click the **Paper** tab and select the paper source, size, and type.
- 5 Click **OK** and print the document.

NOTE: If your printer does not have a duplex unit, you should complete the printing job manually. The printer prints every other page of the document first. After printing the first side of your job, the Printing Tip window appears. Follow the on-screen instructions to complete the printing job.

Printing a Reduced or Enlarged Document

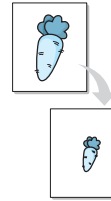

You can change the size of a page’s content to appear larger or smaller on the printed page.

- 1 To change the print settings from your software application, access printer properties. See “Printing a Document” on page 13.
- 2 From the **Paper** tab, select **Reduce/Enlarge** in the **Printing Type** drop-down list.
- 3 Enter the scaling rate in the **Percentage** input box. You can also click the ▼ or ▲ button.
- 4 Select the paper source, size, and type in **Paper Options**.
- 5 Click **OK** and print the document.

Fitting Your Document to a Selected Paper Size

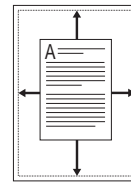

This printer feature allows you to scale your print job to any selected paper size regardless of the digital document size. This can be useful when you want to check fine details on a small document.

- 1 To change the print settings from your software application, access printer properties. See “Printing a Document” on page 13.
- 2 From the **Paper** tab, select **Fit to Page** in the **Printing Type** drop-down list.
- 3 Select the correct size from the **Output size** drop-down list.
- 4 Select the paper source, size, and type in **Paper Options**.
- 5 Click **OK** and print the document.

Using Watermarks

The Watermark option allows you to print text over an existing document. For example, you may want to have large gray letters reading "DRAFT" or "CONFIDENTIAL" printed diagonally across the first page or all pages of a document.

There are several predefined watermarks that come with the printer, and they can be modified, or you can add new ones to the list.

Using an Existing Watermark

- 1 To change the print settings from your software application, access printer properties. See "Printing a Document" on page 13.
- 2 Click the **Extras** tab, and select the desired watermark from the **Watermark** drop-down list. You will see the selected watermark in the preview image.
- 3 Click **OK** and start printing.

NOTE: The preview image shows how the page will look when it is printed.

Creating a Watermark

- 1 To change the print settings from your software application, access printer properties. See "Printing a Document" on page 13.
- 2 Click the **Extras** tab, and click the **Edit** button in the **Watermark** section. The **Edit Watermark** window appears.
- 3 Enter a text message in the **Watermark Message** box. You can enter up to 40 characters. The message displays in the preview window.
When the **First Page Only** box is checked, the watermark prints on the first page only.
- 4 Select watermark options.
You can select the font name, style, size, or grayscale level from the **Font Attributes** section and set the angle of the watermark from the **Message Angle** section.
- 5 Click **Add** to add a new watermark to the list.
- 6 When you have finished editing, click **OK** and start printing.

To stop printing the watermark, select **(No Watermark)** from the **Watermark** drop-down list.

Editing a Watermark

- 1 To change the print settings from your software application, access printer properties. See "Printing a Document" on page 13.
- 2 Click the **Extras** tab and click the **Edit** button in the **Watermark** section. The **Edit Watermark** window appears.
- 3 Select the watermark you want to edit from the **Current Watermarks** list and change the watermark message and options.
- 4 Click **Update** to save the changes.
- 5 Click **OK** until you exit the Print window.

Deleting a Watermark

- 1 To change the print settings from your software application, access printer properties. See "Printing a Document" on page 13.
- 2 From the **Extras** tab, click the **Edit** button in the Watermark section. The **Edit Watermark** window appears.
- 3 Select the watermark you want to delete from the **Current Watermarks** list and click **Delete**.
- 4 Click **OK** until you exit the Print window.

Using Overlays

What is an Overlay?



An overlay is text and/or images stored in the computer hard disk drive (HDD) as a special file format that can be printed on any document. Overlays are often used to take the place of preprinted forms and letterhead paper. Rather than using preprinted letterhead, you can create an overlay containing the exact same information that is currently on your letterhead. To print a letter with your company's letterhead, you do not need to load preprinted letterhead paper in the printer. You need only tell the printer to print the letterhead overlay on your document.

Creating a New Page Overlay



To use a page overlay, you must create a new page overlay containing your logo or image.

- 1 Create or open a document containing text or an image for use in a new page overlay. Position the items exactly as you wish them to appear when printed as an overlay.
- 2 To save the document as an overlay, access printer properties. See "Printing a Document" on page 13.
- 3 Click the **Extras** tab, and click **Edit** button in the **Overlay** section.
- 4 In the Edit Overlay window, click **Create Overlay**.
- 5 In the Create Overlay window, type a name of up to eight characters in the **File name** box. Select the destination path, if necessary. (The default is C:\Formover).
- 6 Click **Save**. The name appears on the **Overlay List** box.
- 7 Click **OK** or **Yes** to finish creating.
The file is not printed. Instead it is stored on your computer hard disk drive.

NOTE: The overlay document size must be the same as the documents you print with the overlay. Do not create an overlay with a watermark.

Using a Page Overlay

After an overlay has been created, it is ready to be printed with your document. To print an overlay with a document:

- 1 Create or open the document you want to print.
- 2 To change the print settings from your software application, access printer properties. See "Printing a Document" on page 13.
- 3 Click the **Extras** tab.
- 4 Select the desired overlay from the **Overlay** drop-down list box.
- 5 If the overlay file you want does not appear in the **Overlay** list, click **Edit** button and **Load Overlay**, and select the overlay file.

If you have stored the overlay file you want to use in an external source, you can also load the file when you access the **Load Overlay** window.

After you select the file, click **Open**. The file appears in the **Overlay List** box and is available for printing. Select the overlay from the **Overlay List** box.

- 6 If necessary, click **Confirm Page Overlay When Printing**. If this box is checked, a message window appears each time you submit a document for printing, asking you to confirm your wish to print an overlay on your document.
If this box is not checked and an overlay has been selected, the overlay automatically prints with your document.
- 7 Click **OK** or **Yes** until printing begins.
The selected overlay downloads with your print job and prints on your document.

NOTE: The resolution of the overlay document must be the same as that of the document you will print with the overlay.

Deleting a Page Overlay

You can delete page overlays that you no longer use.

- 1 In the printer properties window, click the **Extras** tab.
- 2 Click the **Edit** button in the **Overlay** section.
- 3 Select the overlay you want to delete from the **Overlay List** box.
- 4 Click **Delete Overlay**.
- 5 When a confirming message window appears, click **Yes**.
- 6 Click **OK** until you exit the Print window.

4 Sharing the Printer Locally

You can connect the printer directly to a selected computer, which is called “host computer,” on the network.

The following procedure is for Windows XP. For other Windows OS, refer to the corresponding Windows User's Guide or online help.

NOTES:

- Check the Operating System(s) that are compatible with your printer. Please refer to the OS Compatibility section of Printer Specifications in your Printer User's Guide.
 - If you need to know the exact name of your printer, you can check the supplied CD-ROM.
-

Setting Up a Host Computer

- 1 Start Windows.
- 2 From the **Start** menu select **Printers and Faxes**.
- 3 Double-click **your printer driver icon**.
- 4 From the **Printer** menu, select **Sharing**.
- 5 Check the **Share this printer** box.
- 6 Fill in the **Shared Name** field, and then click **OK**.

Setting Up a Client Computer

- 1 Right-click the Windows **Start** button and select **Explore**.
- 2 Select **My Network Places** and then right-click **Search for Computers**.
- 3 Fill in the IP address of host computer in **Computer name** field, and click **Search**. (In case host computer requires **User name** and **Password**, fill in User ID and password of host computer account.)
- 4 Double-click **Printers and Faxes**.
- 5 Right-click printer driver icon, select **Connect**.
- 6 Click **Yes**, if the installation confirm message appears.

5 Using Smart Panel

Smart Panel is a program that monitors and informs you of the status of the printer, and allows you to customize the printer's settings. Smart Panel is installed automatically when you install the printer software.

NOTES:

- To use this program, you need:
 - To check for Operating System(s) that are compatible with your printer, refer to Printer Specifications in your Printer User's Guide.
 - Mac OS X 10.3 or higher
 - Linux. To check for Linux systems that are compatible with your printer, refer to Printer Specifications in your Printer User's Guide.
 - Internet Explorer version 5.0 or higher for flash animation in HTML Help.
- If you need to know the exact name of your printer, you can check the supplied CD-ROM.

Understanding Smart Panel

If an error occurs while printing, Smart Panel appears automatically, showing the error.

You can also launch Smart Panel manually. Double-click the Smart Panel icon on the Windows task bar (in Windows), or Notification Area (in Linux). You can also click it on the status bar (in Mac OS X).

Double-click this icon in Windows.

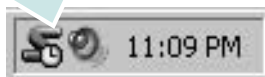

Click this icon in Mac OS X.



Click this icon in Linux.



If you are a Windows user, from the **Start** menu, select **Programs** or **All Programs** → **your printer driver name** → **Smart Panel**.

NOTES:

- If you have already installed more than one Samsung printer, first select the printer model you want in order to use the corresponding Smart Panel. Right-click (in Windows or Linux) or click (in Mac OS X) the Smart Panel icon and select **your printer name**.
- The Smart Panel window and its contents shown in this Software User's Guide may differ depending on the printer or Operating System in use.

The Smart Panel program displays the current status of the printer, the level of toner remaining in the toner cartridge(s) and various other information. You can also change settings.

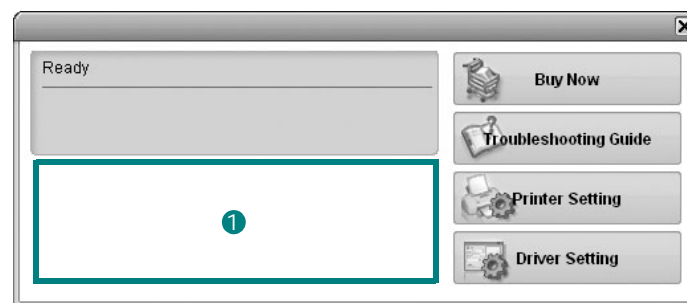

① Toner Level

You can view the level of toner remaining in the toner cartridge(s). The printer and the number of toner cartridge(s) shown in the above window may differ depending on the printer in use. Any printers do not have this feature.

Buy Now

You can order replacement toner cartridge(s) online.

Troubleshooting Guide

You can view Help to solve problems.

Printer Setting

You can configure various printer settings in the Printer Settings Utility window. Any printers do not have this feature.

NOTE: If your printer is connected to a network and you are a Windows and Mac OS X user, the **SyncThru Web Service** window appears instead of the Printer Settings Utility window. Linux does not support network environments.

Driver Setting (Only for Windows)

You can use the printer properties window, which allows you to access all of the printer options you need for using your printer. For details, See “Printer Settings” on page 14.

Opening the Troubleshooting Guide

Using the troubleshooting guide, you can view solutions for error status problems.

Right-click (in Windows or Linux) or click (in Mac OS X) the Smart Panel icon and select **Troubleshooting Guide**.

Using Printer Settings Utility

Using the Printer Settings Utility, you can configure and check print settings.

- 1 Right-click (in Windows or Linux) or click (in Mac OS X) the Smart Panel icon and select **Printer Setting**.
- 2 Change the settings.
- 3 To send the changes to the printer, click the **Apply** button.

NOTES: If your printer is connected to a network, the **SyncThru Web Service** window appears instead of the Printer Settings Utility window.

Using Onscreen Help File

For more information about **Printer Settings Utility**, click  .

Changing the Smart Panel Program Settings

Right-click (in Windows or Linux) or click (in Mac OS X) the Smart Panel icon and select **Options**.

The following window opens.

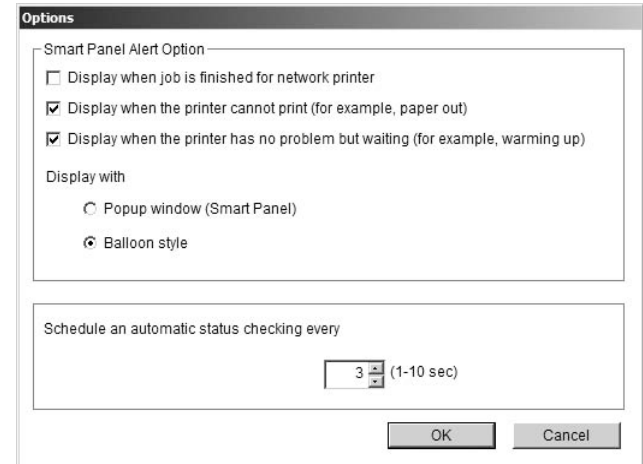

- **Display when job is finished for network printer:** The computer shows the Smart Panel popup window or balloon when your job is complete in Windows. *(Only for Windows network-supported or Macintosh X-supported printers.)*
- **Display when the printer cannot print (for example, paper out):** The computer shows the Smart Panel popup window or balloon when an error occurs during printing.
- **Display when the printer has no problem but waiting (for example, warming up):** The computer shows the Smart Panel popup window or balloon while waiting or warming up the machine.
- **Display with:** You can select how the computer shows you a message. If you select **Popup window (smart panel)**, the message appears in the Smart Panel popup window in Windows.
- **Schedule an automatic status checking every:** The computer updates the printer status regularly. Setting the value close to 1 second causes the computer to check the printer status more frequently, thereby allowing a faster response to any printer error.

6 Using Your Printer in Linux

You can use your machine in a Linux environment.

This chapter includes:

- **Getting Started**
- **Installing the Unified Linux Driver**
- **Using SetIP program**
- **Using the Unified Driver Configurator**
- **Configuring Printer Properties**
- **Printing a Document**

Getting Started

The supplied CD-ROM provides you with Samsung's Unified Linux Driver package for using your machine with a Linux computer.

After the driver is installed on your Linux system, the driver package allows you to monitor a number of machine devices via fast ECP parallel ports and USB simultaneously.

The Unified Linux Driver package is supplied with a smart and flexible installation program. You don't need to search for additional components that might be necessary for the Unified Linux Driver software: all required packages will be carried onto your system and installed automatically; this is possible on a wide set of the most popular Linux clones.

Installing the Unified Linux Driver

Installing the Unified Linux Driver

- 1 Make sure that you connect your machine to your computer. Turn both the computer and the machine on.
- 2 When the Administrator Login window appears, type in *root* in the Login field and enter the system password.

NOTE: You must log in as a super user (*root*) to install the printer software. If you are not a super user, ask your system administrator.

- 3 Insert the printer software CD-ROM. The CD-ROM will automatically run.

If the CD-ROM does not automatically run, click the  icon at the bottom of the desktop. When the Terminal screen appears, type in:

If the CD-ROM is secondary master and the location to mount is `/mnt/cdrom`,

```
[root@localhost root]#mount -t iso9660 /dev/hdc /mnt/cdrom
```

```
[root@localhost root]#cd /mnt/cdrom/Linux
```

```
[root@localhost root]#./install.sh
```

If you still failed to run the CD-ROM, type the followings in sequence:

```
[root@localhost root]#umount /dev/hdc
```

```
[root@localhost root]#mount -t iso9660 /dev/hdc /mnt/cdrom
```

NOTE: The installation program runs automatically if you have an autorun software package installed and configured.

- 4 When the welcome screen appears, click **Next**.

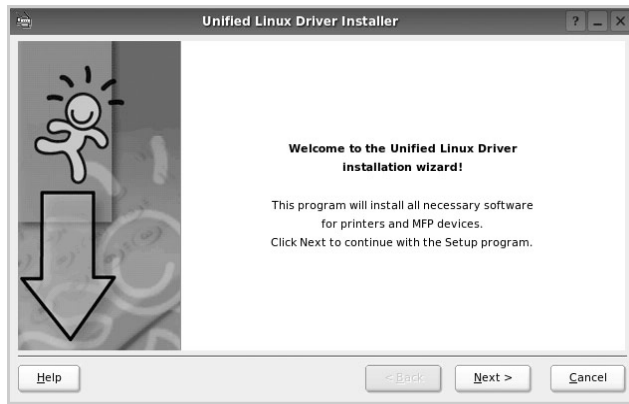

- 5 When the installation is complete, click **Finish**.



The installation program has added the Unified Driver Configurator desktop icon and Samsung Unified Driver group to the system menu for your convenience. If you have any difficulties, consult the onscreen help that is available through your system menu or can otherwise be called from the driver package windows applications, such as **Unified Driver Configurator**.

NOTE: Installing the driver in the text mode:

- If you do not use the graphical interface or have failed the driver installation, you have to use the driver in the text mode.
- Follow the step 1 to 3, then type `[root@localhost Linux]# ./install.sh`, then follow the instruction on the terminal screen. Then the installation completes.
- When you want to uninstall the driver, follow the installation instruction above, but type `[root@localhost Linux]# ./uninstall.sh` on the terminal screen.

Uninstalling the Unified Linux Driver

- 1 When the Administrator Login window appears, type in `root` in the Login field and enter the system password.

NOTE: You must log in as a super user (`root`) to uninstall the printer software. If you are not a super user, ask your system administrator.

- 2 Insert the printer software CD-ROM. The CD-ROM will automatically run.

If the CD-ROM does not automatically run, click the  icon at the bottom of the desktop. When the Terminal screen appears, type in:

If the CD-ROM is secondary master and the location to mount is `/mnt/cdrom`,

```
[root@localhost root]#mount -t iso9660 /dev/hdc /mnt/cdrom
```

```
[root@localhost root]#cd /mnt/cdrom/Linux
```

```
[root@localhost root]#./uninstall.sh
```

NOTE: The installation program runs automatically if you have an autorun software package installed and configured.

- 3 Click **Uninstall**.
- 4 Click **Next**.

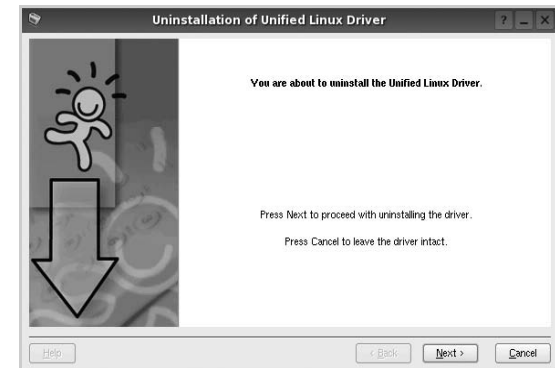

- 5 Click **Finish**.

Using SetIP program

This program is for the network IP setting using the MAC address which is the hardware serial number of the network printer card or interface. Especially, it is for the network administrator to set several network IPs at the same time.

You can only use SetIP program when your machine is connected to a network.

SetIP program should be automatically installed during the printer driver installation.

Starting the program

- 1 Print the machine's network information report which includes your machine's MAC address.
- 2 Open the `/opt/Samsung/mfp/share/utils/`.
- 3 Double click the `SetIPApplet.html` file.
- 4 Click  in the SetIP window to open the TCP/IP configuration window.
- 5 Enter the network card's MAC address, IP address, subnet mask, default gateway, and then click **Apply**.

NOTE: when you enter the MAC address, enter it without colon(:).

- 6 The machine prints the network information. Confirm all the settings are correct.
- 7 Close the SetIP program.

Using the Unified Driver Configurator

Unified Linux Driver Configurator is a tool primarily intended for configuring Printer.

After installing the Unified Linux driver, the Unified Linux Driver Configurator icon will automatically be created on your desktop.

Opening the Unified Driver Configurator

- 1 Double-click **Unified Driver Configurator** on the desktop.
You can also click the Startup Menu icon and select **Samsung Unified Driver** and then **Unified Driver Configurator**.
- 2 Press each button on the Modules pane to switch to the corresponding configuration window.

Printers Configuration button

Ports Configuration button

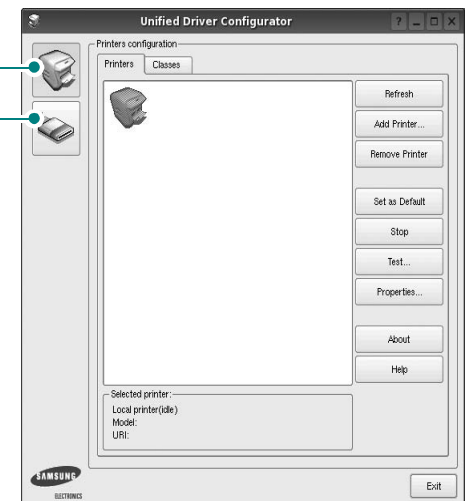

- 3 You can use the onscreen help by clicking **Help**.
- 3 After changing the configurations, click **Exit** to close the Unified Driver Configurator.

Printers Configuration

Printers configuration has the two tabs: **Printers** and **Classes**.

Printers Tab

You can see the current system's printer configuration by clicking on the printer icon button on the left side of the Unified Driver Configurator window.

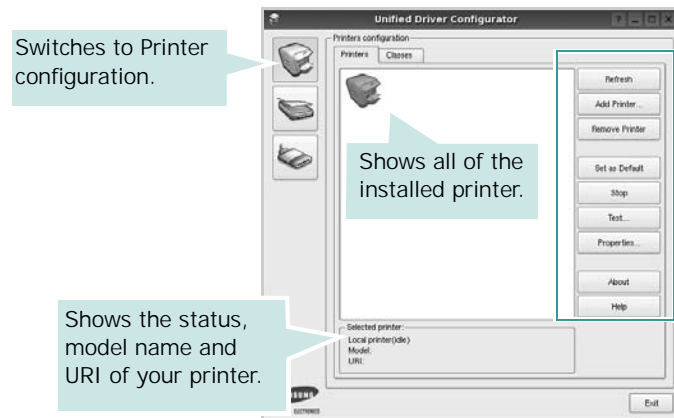

You can use the following printer control buttons:

- **Refresh**: renews the available printers list.
- **Add Printer**: allows you to add a new printer.
- **Remove Printer**: removes the selected printer.
- **Set as Default**: sets the current printer as a default printer.
- **Stop/Start**: stops/starts the printer.
- **Test**: allows you to print a test page to check if the machine is working properly.
- **Properties**: allows you to view and change the printer properties. For details, see page 31.

Classes Tab

The Classes tab shows a list of available printer classes.

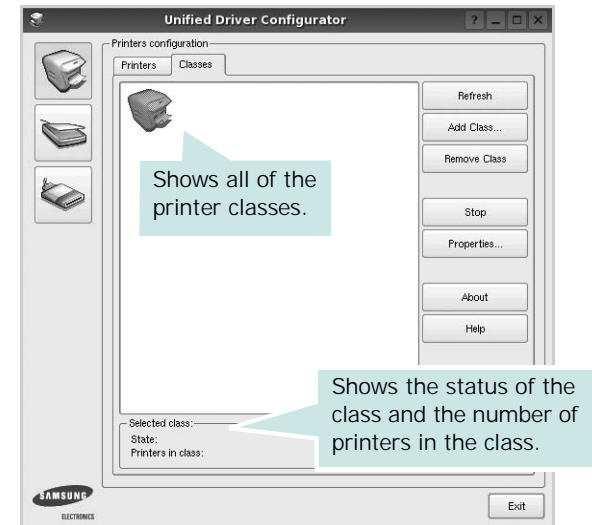

- **Refresh** : Renews the classes list.
- **Add Class...** : Allows you to add a new printer class.
- **Remove Class** : Removes the selected printer class.

Ports Configuration

In this window, you can view the list of available ports, check the status of each port and release a port that is stalled in busy state when its owner is terminated for any reason.

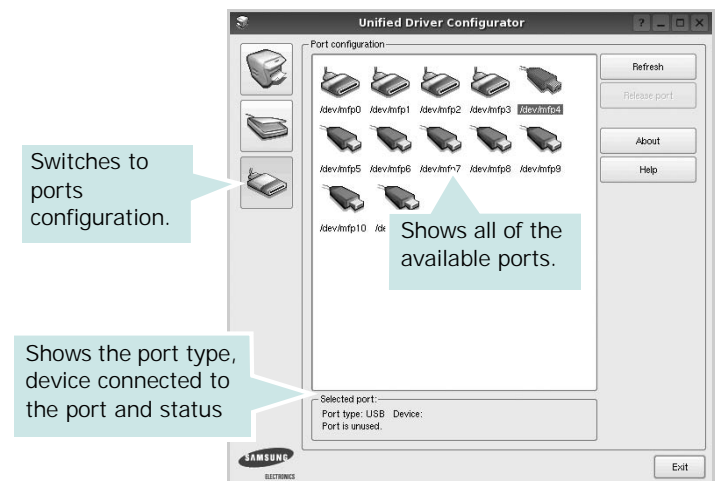

- **Refresh** : Renews the available ports list.
- **Release port** : Releases the selected port.

Configuring Printer Properties

Using the properties window provided by the Printers configuration, you can change the various properties for your machine as a printer.

- 1 Open the Unified Driver Configurator.
If necessary, switch to Printers configuration.
- 2 Select your machine on the available printers list and click **Properties**.
- 3 The Printer Properties window opens.

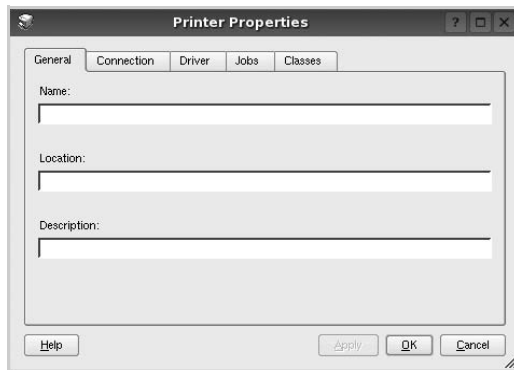

The following five tabs display at the top of the window:

- **General:** allows you to change the printer location and name. The name entered in this tab displays on the printer list in Printers configuration.
 - **Connection:** allows you to view or select another port. If you change the printer port from USB to parallel or vice versa while in use, you must re-configure the printer port in this tab.
 - **Driver:** allows you to view or select another printer driver. By clicking **Options**, you can set the default device options.
 - **Jobs:** shows the list of print jobs. Click **Cancel job** to cancel the selected job and select the **Show completed jobs** check box to see previous jobs on the job list.
 - **Classes:** shows the class that your printer is in. Click **Add to Class** to add your printer to a specific class or click **Remove from Class** to remove the printer from the selected class.
- 4 Click **OK** to apply the changes and close the Printer Properties Window.

Printing a Document

Printing from Applications

There are a lot of Linux applications that you are allowed to print from using Common UNIX Printing System (CUPS). You can print on your machine from any such application.

- 1 From the application you are using, select **Print** from the **File** menu.
- 2 Select **Print** directly using **lpr**.
- 3 In the LPR GUI window, select the model name of your machine from the Printer list and click **Properties**.

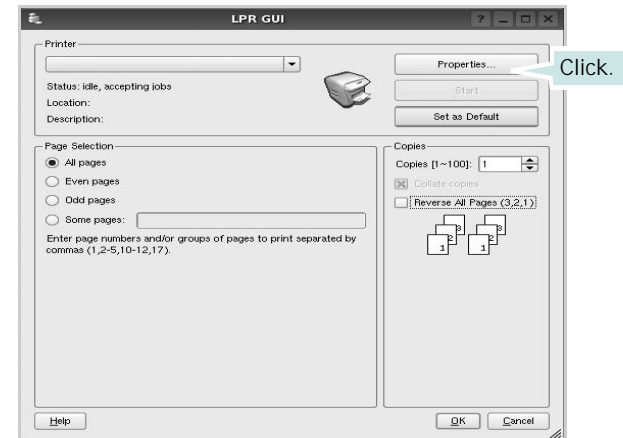

- 4 Change the printer and print job properties.

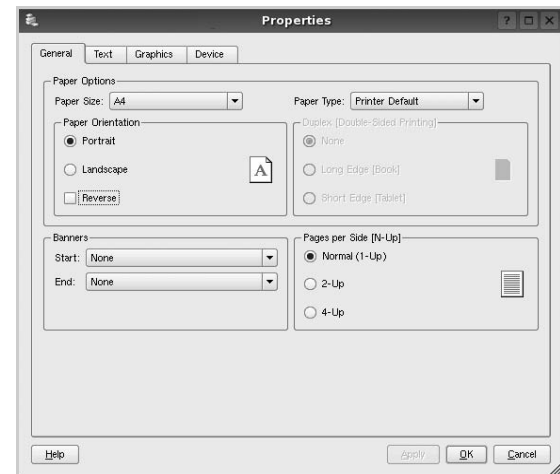

The following four tabs display at the top of the window.

- **General** - allows you to change the paper size, the paper type, and the orientation of the documents, enables the duplex feature, adds start and end banners, and changes the number of pages per sheet.
- **Text** - allows you to specify the page margins and set the text options, such as spacing or columns.
- **Graphics** - allows you to set image options that are used when printing images/files, such as color options, image size, or image position.
- **Device**: allows you to set the print resolution, paper source, and destination.

5 Click **Apply** to apply the changes and close the Properties window.

6 Click **OK** in the LPR GUI window to start printing.

7 The Printing window appears, allowing you to monitor the status of your print job.

To abort the current job, click **Cancel**.

Printing Files

You can print many different types of files on the Samsung machine device using the standard CUPS way - directly from the command line interface. The CUPS `lpr` utility allows you to do that. But the drivers package replaces the standard `lpr` tool by a much more user-friendly LPR GUI program.

To print any document file:

1 Type `lpr <file_name>` from the Linux shell command line and press **Enter**. The LPR GUI window appears.

When you type only `lpr` and press **Enter**, the Select file(s) to print window appears first. Just select any files you want to print and click **Open**.

2 In the LPR GUI window, select your printer from the list, and change the printer and print job properties.

For details about the properties window, see page 31.

3 Click **OK** to start printing.

7 Using Your Printer with a Macintosh

Your printer supports Macintosh systems with a built-in USB interface or 10/100 Base-TX network interface card. When you print a file from a Macintosh computer, you can use the CUPS driver by installing the PPD file.

NOTE: *Some printers do not support a network interface. Make sure that your printer supports a network interface by referring to Printer Specifications in your Printer User's Guide.*

This chapter includes:

- **Installing Software**
- **Using SetIP program**
- **Setting Up the Printer**
- **Printing**

Installing Software

The CD-ROM that came with your printer provides you with the PPD file that allows you to use the CUPS driver or Apple LaserWriter driver (*only available when you use a printer which supports the PostScript driver*), for printing on a Macintosh computer.

Printer driver

Installing the Printer driver

- 1** Make sure that you connect your printer to the computer. Turn on your computer and printer.
- 2** Insert the CD-ROM which came with your printer into the CD-ROM drive.
- 3** Double-click **CD-ROM icon** that appears on your Macintosh desktop.
- 4** Double-click the **MAC_Installer** folder.
- 5** Double-click the **MAC_Printer** folder.
- 6** Double-click the **Samsung SPLC Installer** icon.
- 7** Enter the password and click **OK**.
- 8** The Samsung SPL Installer window opens. Click **Continue** and then click **Continue**.
- 9** Select **Easy Install** and click **Install**.
- 10** After the installation is finished, click **Quit**.

Uninstalling the Printer driver

Uninstall is required if you are upgrading the software, or if installation fails.

- 1** Insert the CD-ROM which came with your printer into the CD-ROM drive.
- 2** Double-click **CD-ROM icon** that appears on your Macintosh desktop.
- 3** Double-click the **MAC_Installer** folder.
- 4** Double-click the **MAC_Printer** folder.
- 5** Double-click the **Samsung SPLC Installer** icon.
- 6** Enter the password and click **OK**.
- 7** The Samsung SPL Installer window opens. Click **Continue** and then click **Continue**.
- 8** Select **Uninstall** and then click **Uninstall**.
- 9** When the uninstallation is done, click **Quit**.

Using SetIP program

This program is for the network IP setting using the MAC address which is the hardware serial number of the network printer card or interface. Especially, it is for the network administrator to set several network IPs at the same time.

You can only use SetIP program when your machine is connected to a network.

SetIP program should be automatically installed during the printer driver installation.

NOTE: If you select **Typical installation for a network printer** during the printer driver installation, the SetIP program automatically runs after the installation. Follow the below instruction.

- 1 The certificate window appears, click **Trust**.
- 2 Print the machine's network information report which includes your machine's MAC address.
- 3 Click  in the SetIP window to open the TCP/IP configuration window.
- 4 Enter the network card's MAC address, IP address, subnet mask, default gateway, and then click **Apply**.

NOTE: when you enter the MAC address, enter it without colon(:).

- 5 The machine prints the network information. Confirm all the settings are correct.
- 6 Close the SetIP program.

Starting the program

If you want to change your network printer IP setting, follow the below instruction.

- 1 Print the machine's network information report which includes your machine's MAC address.
- 2 Open the **Library** folder → **Printers** → **Samsung** → **Your printer model name** → **SetIP**.
- 3 Double click the **SetIPApplet.html** file.
- 4 The certificate window appears, click **Trust**.
- 5 Click  in the SetIP window to open the TCP/IP configuration window.
- 6 Enter the network card's MAC address, IP address, subnet mask, default gateway, and then click **Apply**. when you enter the MAC address, enter it without colon(:).
- 7 The machine prints the network information. Confirm all the settings are correct.
- 8 Close the SetIP program.

Setting Up the Printer

Set up for your printer will be different depending on which cable you use to connect the printer to your computer—the network cable or the USB cable.

For a Network-connected

NOTE: *Some printers do not support a network interface. Before connecting your printer, make sure that your printer supports a network interface by referring to Printer Specifications in your Printer User's Guide.*

- 1 Follow the instructions on "Installing Software" on page 33 to install the PPD and Filter files on your computer.
- 2 Open the **Applications** folder → **Utilities**, and **Print Setup Utility**.
 - For MAC OS 10.5, open **System Preferences** from the **Applications** folder, and click **Printer & Fax**.
- 3 Click **Add** on the **Printer List**.
 - For MAC OS 10.5, press the "+" icon then a display window will pop up.
- 4 For MAC OS 10.3, select the **IP Printing** tab.
 - For MAC OS 10.4, click **IP Printer**.
 - For MAC OS 10.5, click **IP**.
- 5 Select **Socket/HP Jet Direct** in **Printer Type**.
WHEN PRINTING A DOCUMENT CONTAINING MANY PAGES, PRINTING PERFORMANCE MAY BE ENHANCED BY CHOOSING SOCKET FOR PRINTER TYPE OPTION.
- 6 Enter the printer's IP address in the **Printer Address** field.
- 7 Enter the queue name in the **Queue Name** field. If you cannot determine the queue name for your printer server, try using the default queue first.
- 8 For MAC OS 10.3, if Auto Select does not work properly, select **Samsung** in **Printer Model** and **your printer name** in **Model Name**.
 - For MAC OS 10.4, if Auto Select does not work properly, select **Samsung** in **Print Using** and **your printer name** in **Model**.
 - For MAC OS 10.5, if Auto Select does not work properly, select **Select a driver to use...** and **your printer name** in **Print Using**.Your printer's IP address appears on the **Printer List**, and is set as the default printer.
- 9 Click **Add**.

For a USB-connected

- 1 Follow the instructions on “Installing Software” on page 33 to install the PPD and Filter files on your computer.
- 2 Open the **Applications** folder → **Utilities**, and **Print Setup Utility**.
 - For MAC OS 10.5, open **System Preferences** from the **Applications** folder, and click **Printer & Fax**.
- 3 Click **Add** on the **Printer List**.
 - For MAC OS 10.5, press the “+” icon then a display window will pop up.
- 4 For MAC OS 10.3, select the **USB** tab.
 - For MAC OS 10.4, click **Default Browser** and find the USB connection.
 - For MAC OS 10.5, click **Default** and find the USB connection.
- 5 For MAC OS 10.3, if Auto Select does not work properly, select **Samsung** in **Printer Model** and **your printer name** in **Model Name**.
 - For MAC OS 10.4, if Auto Select does not work properly, select **Samsung** in **Print Using** and **your printer name** in **Model**.
 - For MAC OS 10.5, if Auto Select does not work properly, select **Select a driver to use...** and **your printer name** in **Print Using**.

Your machine appears on the Printer List and is set as the default printer.
- 6 Click **Add**.

Printing

NOTES:

- The Macintosh printer's properties window that appears in this User's Guide may differ depending on the printer in use. However the composition of the printer properties window is similar.
- *You can check your printer name in the supplied CD-ROM.*

Printing a Document

When you print with a Macintosh, you need to check the printer software setting in each application you use. Follow these steps to print from a Macintosh.

- 1 Open a Macintosh application and select the file you want to print.
- 2 Open the **File** menu and click **Page Setup (Document Setup** in some applications).
- 3 Choose your paper size, orientation, scaling, and other options and click **OK**.

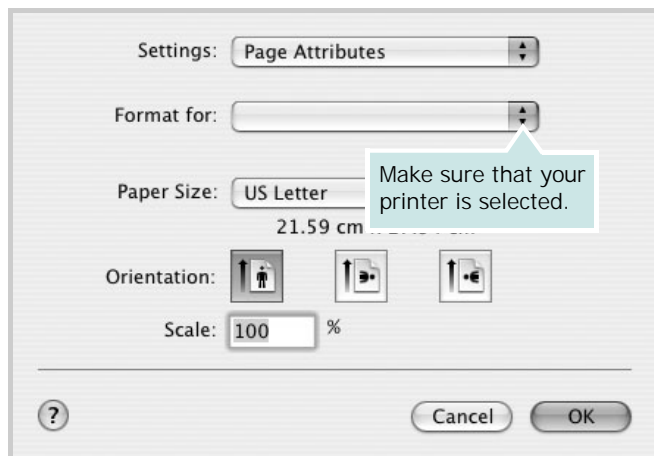

▲ Mac OS 10.3

- 4 Open the **File** menu and click **Print**.
- 5 Choose the number of copies you want and indicate which pages you want to print.
- 6 Click **Print** when you finish setting the options.

Changing Printer Settings

You can use advanced printing features when using your printer.

From your Macintosh application, select **Print** from the **File** menu. The printer name which appears in the printer properties window may differ depending on the printer in use. Except for the name, the composition of the printer properties window is similar.

NOTES: The setting options may differ depending on printers and Macintosh OS version.

Layout

The **Layout** tab provides options to adjust how the document appears on the printed page. You can print multiple pages on one sheet of paper. Select **Layout** from the **Presets** drop-down list to access the following features.

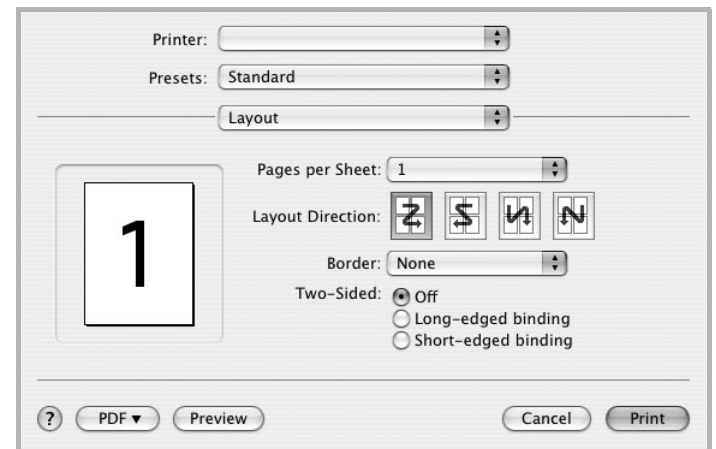

▲ Mac OS 10.4

- **Pages per Sheet:** This feature determines how many pages printed on one page. For details, see "Printing Multiple Pages on One Sheet of Paper" on the next column.
- **Layout Direction:** You can select the printing direction on a page as like the examples on UI.

Graphics

The **Graphics** tab provides options for selecting **Resolution(Quality)** and **Color Mode**. Select **Graphics** from the **Presets**' drop-down list to access the graphic features.

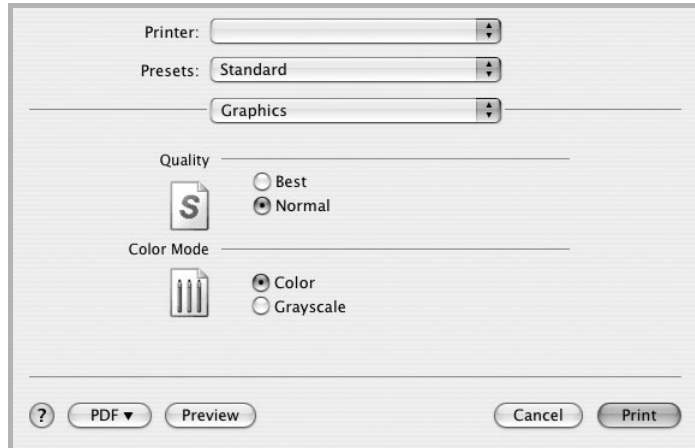

▲ Mac OS 10.4

- **Resolution(Quality)**: You can select the printing resolution. The higher the setting, the sharper the clarity of printed characters and graphics. The higher setting also may increase the time it takes to print a document.
- **Color Mode**: You can set the color options. Setting to **Color** typically produces the best possible print quality for color documents. If you want to print a color document in grayscale, select **Grayscale**.

Paper

Set **Paper Type** to correspond to the paper loaded in the tray from which you want to print. This will let you get the best quality printout. If you load a different type of print material, select the corresponding paper type.

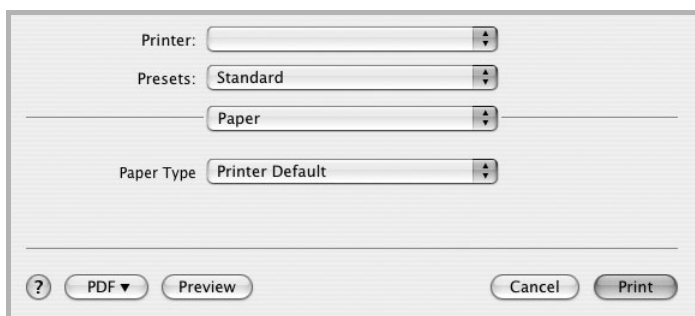

▲ Mac OS 10.4

Printer Features

This tab provides options for selecting the paper type and adjusting print quality. Select **Printer Features** from the **Presets**' drop-down list to access the following features:

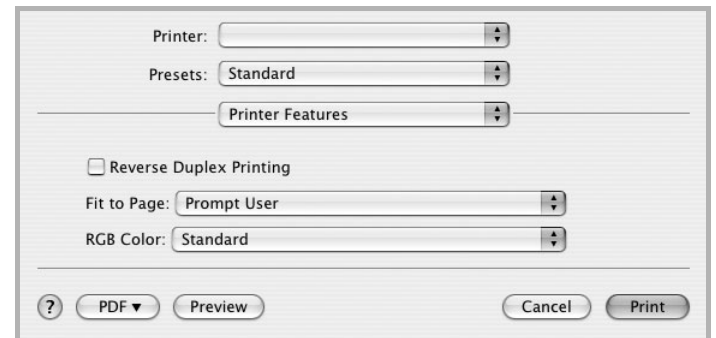

▲ Mac OS 10.4

- **Fit to Page**: This setting allows you to scale your print job to any selected paper size regardless of the digital document size. This can be useful when you want to check fine details on a small document.
- **RGB Color**: This setting determines how colors are rendered. **Standard** is the most widely used setting which the color tone of this mode is the closest to that of standard monitor (sRGB Monitor). **Vivid** mode is appropriate for printing presentation data and charts. The color tone of Vivid mode produces more **Vivid** color images than that of Standard mode. **Device** mode is best used for printing fine lines, small characters and color drawings. The color tone of **Device** mode may be different from that of monitor, the pure toner colors are used for printing Cyan, Magenta and Yellow colors.

Printing Multiple Pages on One Sheet of Paper

You can print more than one page on a single sheet of paper. This feature provides a cost-effective way to print draft pages.

- 1 From your Macintosh application, select **Print** from the **File** menu.
- 2 Select **Layout**.

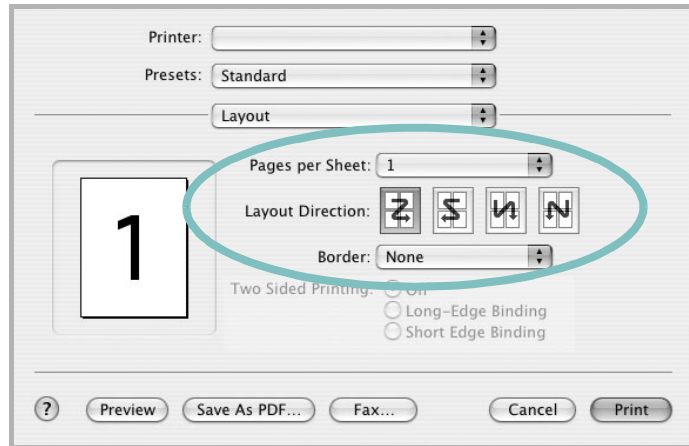

▲ Mac OS 10.3

- 3 Select the number of pages you want to print on one sheet of paper on the **Pages per Sheet** drop-down list.
- 4 Select the page order from the **Layout Direction** option.
To print a border around each page on the sheet, select the option you want from the **Border** drop-down list.
- 5 Click **Print**, and the printer prints the selected number of pages on one side of each page.

SOFTWARE SECTION

INDEX

A

advanced printing, use 19

B

booklet printing 20

D

document, print
Macintosh 36
Windows 13

double-sided printing 21

E

Extras properties, set 17

F

favorites settings, use 18

G

Graphics properties, set 16

H

help, use 18

I

install
printer driver
Macintosh 33
Windows 4
installing
Linux software 27

L

language, change 10
Layout properties, set

Windows 15
Linux
driver, install 27
printer properties 31
printing 31

M

Macintosh
driver
install 33
uninstall 33
printing 36
setting up the printer 34
MFP driver, install
Linux 27

N

n-up printing
Macintosh 38
Windows 19

O

orientation, print 32
Windows 15
overlay
create 23
delete 23
print 23

P

Paper properties, set 15
paper size, set 15
print 32
paper source, set 32
Windows 16
paper type, set
print 32
poster, print 20
print
document 13

fit to page 21
from Macintosh 36
from Windows 13
N-up
Macintosh 38
Windows 19
overlay 23
poster 22
PRN 14
scaling 21
watermark 22
print resolution 32
printer driver, install
Linux 27
printer properties
Linux 31
printer properties, set
Macintosh 36
Windows 14
printer resolution, set
Windows 16
printer software
install
Macintosh 33
Windows 4
uninstall
Macintosh 33
Windows 11
printing
booklets 20
double-sided 21
from Linux 31

R

resolution
printing 32

S

setting
darkness 16
favorites 18
image mode 16
resolution

- Windows 16
- toner save 16
- true-type option 16
- software
 - install
 - Macintosh 33
 - Windows 4
 - reinstall
 - Windows 10
 - system requirements
 - Macintosh 33
 - uninstall
 - Macintosh 33
 - Windows 11
- status monitor, use 25

T

- toner save, set 16

U

- uninstall, software
 - Macintosh 33
 - Windows 11
- uninstalling
 - MFP driver
 - Linux 28

W

- watermark
 - create 22
 - delete 22
 - edit 22
 - print 22

